

CENOVNIK PROFILA

roloplast



**važeći od
01.06.2026**

SISTEMSKI METAR

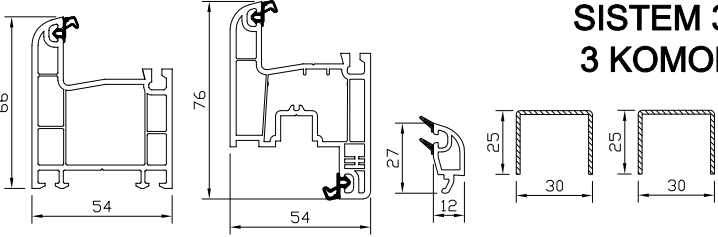
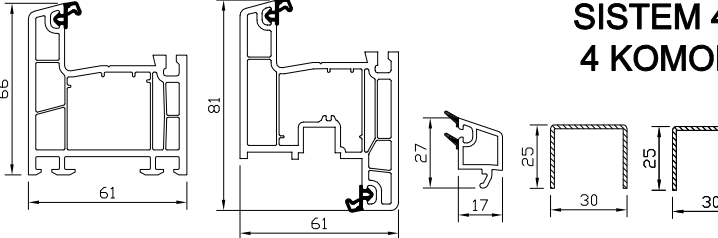
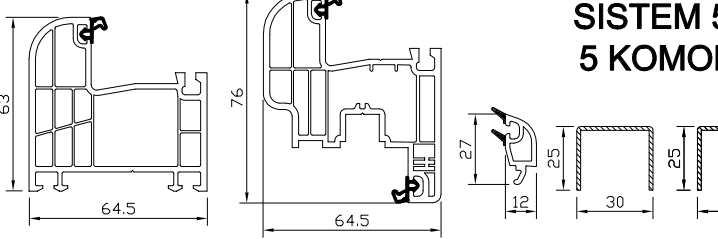
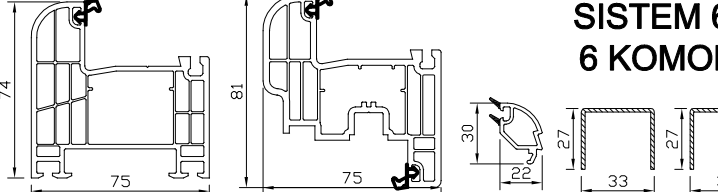
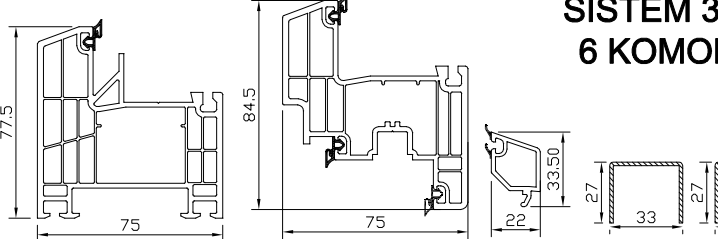
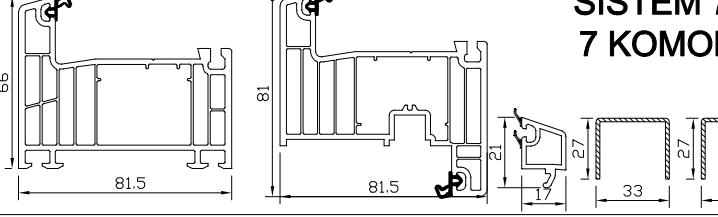
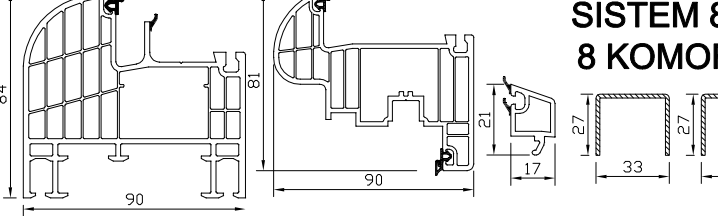
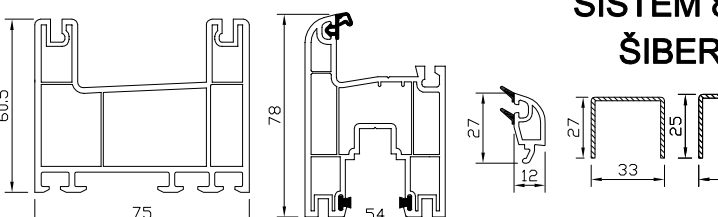
PRIKAZ	BOJA	CENA BEZ PDV-A (EURO/m)	CENA SA PDV-OM (EURO/m)
 <p>SISTEM 300 3 KOMORE</p>	Bela sa dihtungom	7.7675	9.3210
 <p>SISTEM 400 4 KOMORE</p>	Bela sa dihtungom	9.5375	11.4450
 <p>SISTEM 500 5 KOMORA</p>	Bela sa dihtungom	8.5900	10.3080
 <p>SISTEM 600 6 KOMORA</p>	Bela sa dihtungom	9.8800	11.8560
	Laminirana sa dihtungom	16.4115	19.6938
	Antracit spolja sa dihtungom	12.6625	15.1950
 <p>SISTEM 3600 6 KOMORA</p>	Bela sa dihtungom	10.1298	12.1557
	Laminirana sa dihtungom	16.6240	19.9488
	Antracit spolja sa dihtungom	14.1440	16.9728
 <p>SISTEM 700 7 KOMORA</p>	Bela sa dihtungom	10.5675	12.6810
	Laminirana sa dihtungom	15.7705	18.9246
	Antracit spolja sa dihtungom	13.2235	15.8682
 <p>SISTEM 800 8 KOMORA</p>	Bela sa dihtungom	11.5000	13.8000
 <p>SISTEM 800 ŠIBER</p>	Bela sa dihtungom i četkicama	8.9000	10.6800

SISTEM 300 - 3 KOMORA

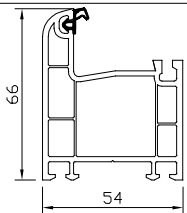
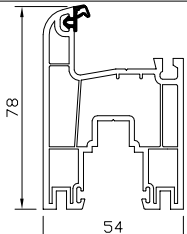
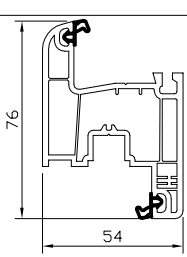
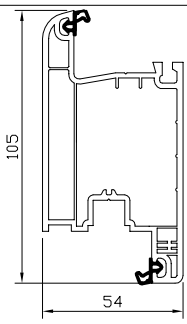
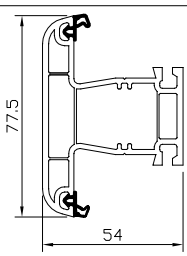
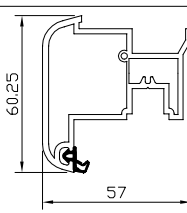
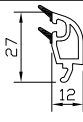
PROFILI	NAZIV PROFILA	Šifra Proiz.	BOJA	Korpa Kom / m	CENA BEZ PDV-A (EURO/m)	CENA SA PDV-OM (EURO/m)
	PVC profil 301 - ram Frame profile (301)	60112	Bela	121 kom / 726m	2.350	2.820
			Bela sa dihtungom	121 kom / 726m	2.480	2.976
	PVC profil 810 - prošireni ram Frame profile (810)	60706	Bela	99 kom / 594m	2.938	3.525
			Bela sa dihtungom	99 kom / 594m	3.068	3.681
	PVC profil 310 - krilo prozora Sash profile (310)	60113	Bela	121 kom / 726m	2.233	2.679
			Bela sa dihtungom	121 kom / 726m	2.493	2.991
	PVC profil 311 - krilo vrata Entrance door sash profile (311)	60114	Bela	77 kom / 462m	2.938	3.525
			Bela sa dihtungom	77 kom / 462m	3.198	3.837
	PVC profil 320 - stub Mullion profile (320)	60115	Bela	121 kom / 726m	2.233	2.679
			Bela sa dihtungom	121 kom / 726m	2.493	2.991
	PVC profil 321 - lažna prečka Sash adapting profile (321)	60116	Bela	154 kom / 924m	1.880	2.256
			Bela sa dihtungom	154 kom / 924m	2.010	2.412
	PVC profil 330 - lajsna za staklo Glassbed profile (330)	60105	Bela sa dihtungom	840 kom / 5040m	0.475	0.570



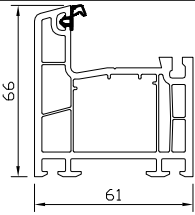
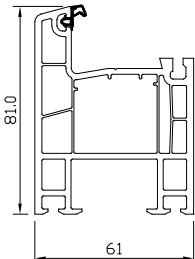
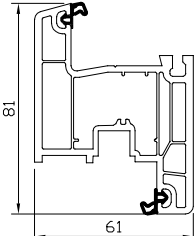
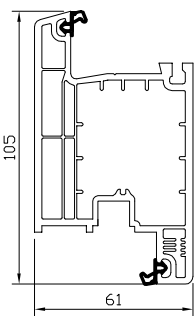
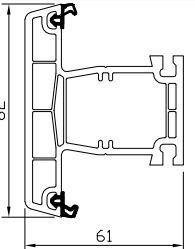
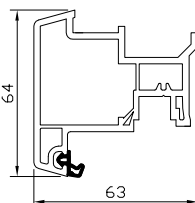
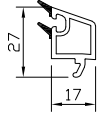

SISTEM 400 - 4 KOMORA

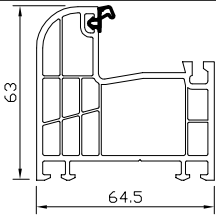
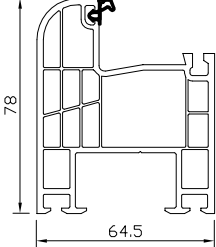
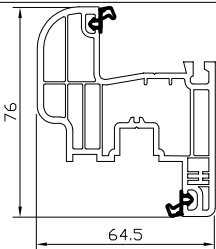
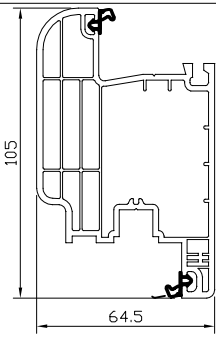
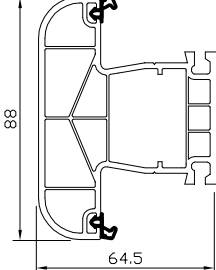
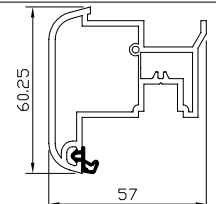
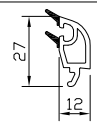
PROFILI	NAZIV PROFILA	Šifra Proiz.	BOJA	Korpa Kom / m	CENA BEZ PDV-A (EURO/m)	CENA SA PDV-OM (EURO/m)
	PVC profil 401 - ram Frame profile (401)		Bela	110 kom / 660m	3.055	3.666
		60212	Bela sa dihtungom	110 kom / 660m	3.185	3.822
	PVC profil 403 - ram Frame profile (403)		Bela	72 kom / 432m	3.173	3.807
		60213	Bela sa dihtungom	72 kom / 432m	3.433	4.119
	PVC profil 410 - krilo prozora Sash profile (410)		Bela	100 kom / 600m	3.173	3.807
		60214	Bela sa dihtungom	100 kom / 600m	3.433	4.119
	PVC profil 411 - krilo vrata Entrance door sash profile (411)		Bela	72 kom / 432m	3.760	4.512
		60215	Bela sa dihtungom	72 kom / 594m	4.020	4.824
	PVC profil 420 - stub Mullion profile (420)		Bela	99 kom / 594m	2.820	3.384
		60216	Bela sa dihtungom	99 kom / 432m	3.080	3.696
	PVC profil 421 - lažna prečka Sash adapting profile (421)		Bela	112 kom / 672m	2.350	2.820
		60217	Bela sa dihtungom	112 kom / 672m	2.480	2.976
	PVC profil 431 - lajsna za staklo Glassbed profile (431)	60206	Bela	640 kom / 3600m	0.600	0.720

SISTEM 500 - 5 KOMORA

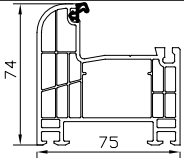
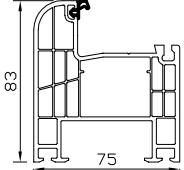
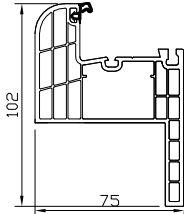
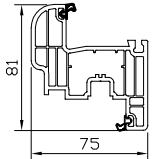
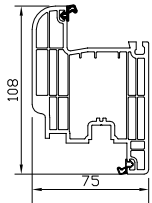
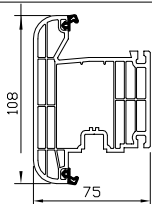
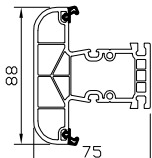
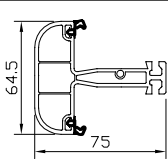
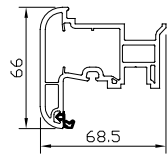
PROFILI	NAZIV PROFILA	Šifra Proiz.	BOJA	Korpa Kom / m	CENA BEZ PDV-A (EURO/m)	CENA SA PDV-OM (EURO/m)
	PVC profil 501 - ram Frame profile (501)	60312	Bela	108 kom / 648m	2.585	3.102
			Bela sa dihtungom	108 kom / 648m	2.715	3.258
	PVC profil 503 - prošireni ram Frame profile (503)	60316	Bela	81 kom / 486m	3.055	3.666
			Bela sa dihtungom	81 kom / 486m	3.185	3.822
	PVC profil 510 - krilo prozora Sash profile (510)	60313	Bela	99 kom / 594m	2.820	3.384
			Bela sa dihtungom	99 kom / 594m	3.080	3.696
	PVC profil 511 - krilo vrata Entrance door sash profile (511)	60319	Bela	63 kom / 376m	3.290	3.948
			Bela sa dihtungom	63 kom / 376m	3.550	4.250
	PVC profil 520 - stub Mullion profile (520)	60318	Bela	81 kom / 486m	3.055	3.666
			Bela sa dihtungom	81 kom / 486m	3.315	3.978
	PVC profil 321 - lažna prečka Sash adapting profile 321	60116	Bela	160 kom / 960m	1.880	2.256
			Bela sa dihtungom	160 kom / 960m	2.010	2.412
	PVC profil 330 -lajsna za staklo Glassbed profile 330	60105	Bela sa dihtungom	840 kom / 4200m	0.475	0.570

SISTEM 600 - 6 KOMORA

PROFILI	NAZIV PROFILA	Šifra Proiz.	BOJA	Korpa Kom / m	CENA BEZ PDV-A (EURO/m)	CENA SA PDV-OM (EURO/m)
	PVC profil 601 - ram Frame profile (601)		Bela	80 kom / 480m	3.173	3.807
		60412	Bela sa dihtungom	80 kom / 480m	3.303	3.963
	PVC profil 603 - prošireni ram Frame profile (603)		Bela	72 kom / 432m	3.572	4.286
		60418	Bela sa dihtungom	72 kom / 432m	3.702	4.442
		60626	Laminirana sa dihtungom	72 kom / 432m	6.486	7.783
		60635	Antracit spolja sa dihtungom	72 kom / 432m	5.398	6.478
	PVC profil 605 - ram sa pervajzom Frame profile (605)	60424	Bela sa dihtungom	64 kom / 384m	3.185	3.822
		60634	Laminirana sa dihtungom	64 kom / 384m	6.049	7.259
			Bela	64 kom / 384m	3.055	3.666
	PVC profil 610 - krilo prozora Sash profile (610)	60413	Bela sa dihtungom	80 kom / 480m	3.433	4.119
		60620	Laminirana sa dihtungom	80 kom / 480m	5.993	7.191
		60636	Antracit spolja sa dihtungom	80 kom / 480m	4.745	5.693
	PVC profil 611 - krilo vrata Entrance door - sash profile (611)	60414	Bela sa dihtungom	56 kom / 336m	4.725	5.670
		60621	Laminirana sa dihtungom	56 kom / 336m	8.165	9.798
		60639	Antracit spolja sa dihtungom	56 kom / 336m	6.485	7.782
	PVC profil 612 - krilo vrata za spoljašnje otvaranje Entrance door sash profile for external opening (612)	60415	Bela sa dihtungom	56 kom / 336m	4.583	5.499
		60630	Laminirana sa dihtungom	56 kom / 336m	8.283	9.939
			Bela	56 kom / 336m	4.465	5.358
	PVC profil 620 - stub Mullion profile (620)	60416	Bela sa dihtungom	72 kom / 432m	4.138	4.965
		60622	Laminirana sa dihtungom	72 kom / 432m	6.986	8.383
		60637	Antracit spolja sa dihtungom	72 kom / 432m	6.186	7.423
	PVC profil 622 - stub Mullion profile (622)	60419	Bela sa dihtungom	112 kom / 672m	2.493	2.991
		60633	Laminirana sa dihtungom	112 kom / 672m	4.589	5.506
			Bela	112 kom / 672m	2.233	2.679
	PVC profil 621 - lažna prečka Sash adapting profile (621)	60417	Bela sa dihtungom	117 kom / 702m	2.715	3.258
		60623	Laminirana sa dihtungom	117 kom / 702m	4.795	5.754
		60638	Antracit spolja sa dihtungom	117 kom / 702m	4.139	4.967
	PVC profil 630 - lajsna za staklo Glassbed profile (630)	60406	Bela sa dihtungom	500 kom / 3000m	0.725	0.870
		60606	Laminirana sa dihtungom		1.413	1.696
	PVC profil 631 - lajsna za staklo Glassbed profile (631)	60420	Bela sa dihtungom	560kom / 3360m	0.625	0.750
	PVC profil 330 - lajsna za troslojno staklo Glassbed profile (330)	60105	Bela sa dihtungom	840 kom / 5040m	0.475	0.570
		60118	Laminirana sa dihtungom		1.214	1.457

SISTEM 3600 - 6 KOMORA

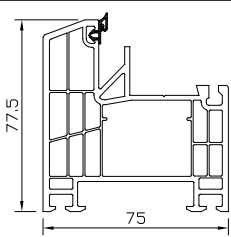
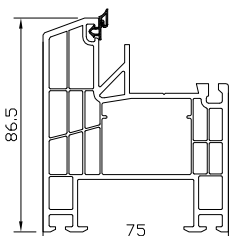
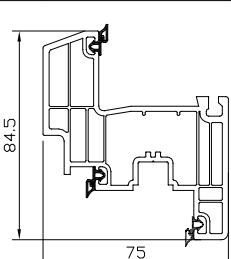
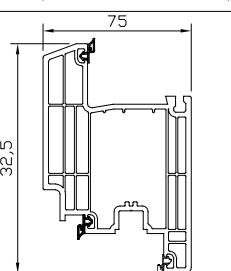
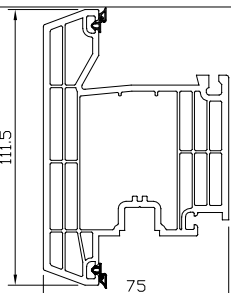
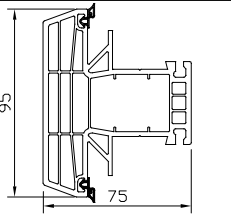
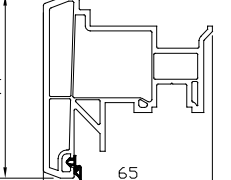
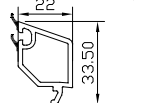
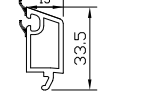
PROFILI	NAZIV PROFILA	Šifra Proiz.	BOJA	Korpa Kom / m	CENA BEZ PDV-A (EURO/m)	CENA SA PDV-OM (EURO/m)
	PVC profil 3602 - ram Frame profile (3602)		Bela	80 kom / 480m	3.372	4.047
		62601	Bela sa dihtungom	80 kom / 480m	3.502	4.203
	PVC profil 3603 - ram Frame profile (3603)		Bela	64 kom / 512m	3.643	4.371
		62602	Bela sa dihtungom	64 kom / 512m	3.773	4.527
		62701	Laminirana sa dihtungom	64 kom / 512m	6.621	7.945
		60635	Antracit spolja sa dihtungom	64 kom / 512m	5.533	6.639
	PVC profil 3610 - krilo prozora Sash profile (3610)		Bela	72 kom / 432m	3.173	3.807
		62603	Bela sa dihtungom	72 kom / 432m	3.433	4.119
		62702	Laminirana sa dihtungom	72 kom / 432m	6.073	7.287
			Antracit spolja sa dihtungom	72 kom / 432m	4.681	5.617
	PVC profil 3611 - krilo vrata Entrance door sash profile (3611)		Bela	48 kom / 288m	4.630	5.555
		62604	Bela sa dihtungom	48 kom / 288m	4.890	5.867
		62703	Laminirana sa dihtungom	48 kom / 288m	8.826	10.591
			Antracit spolja sa dihtungom	48 kom / 288m	6.970	8.363
	PVC profil 3612 - krilo vrata za spoljašnje otvaranje Entrance door sash profile for external opening (3612)		Bela	56 kom / 336m	4.653	5.584
		62605	Bela sa dihtungom	56 kom / 336m	4.913	5.896
		62704	Laminirana sa dihtungom	56 kom / 336m	8.353	10.024
	PVC profil 3620 - stub Mullion profile (3620)		Bela	72 kom / 432m	4.700	5.640
		62606	Bela sa dihtungom	72 kom / 432m	4.960	5.952
		62704	Laminirana sa dihtungom	72 kom / 432m	8.000	9.600
		60637	Antracit spolja sa dihtungom	72 kom / 432m	7.200	8.640
	PVC profil 3621 - lažna prečka Sash adapting profile (3621)	62607	Bela sa dihtungom	117 kom / 702m	2.644	3.173
		62705	Laminirana sa dihtungom	117 kom / 702m	5.030	6.036
		60638	Antracit spolja sa dihtungom	117 kom / 702m	4.374	5.249
			Bela	117 kom / 702m	2.644	3.173
	PVC profil 3630 - lajsna za staklo Glassbed profile (3630)	62608	Bela sa dihtungom	500 kom / 3000m	0.675	0.810
		62705	Laminirana sa dihtungom	500 kom / 3000m	1.411	1.693
	PVC profil 3631 - lajsna za troslojno staklo Glassbed profile (3631)	62617	Bela sa dihtungom	500 kom / 3000m	0.625	0.750
			Laminirana sa dihtungom	500 kom / 3000m	1.281	1.537



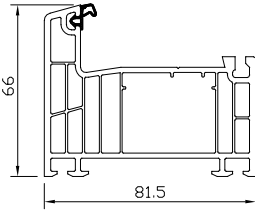
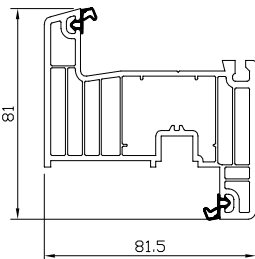
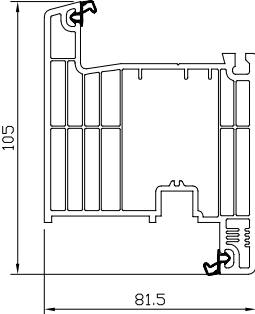
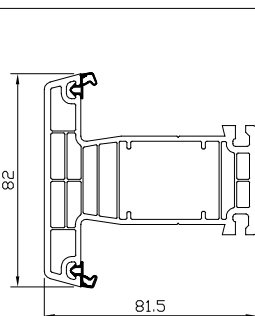
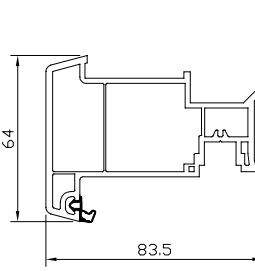
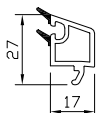
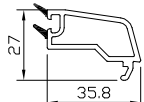

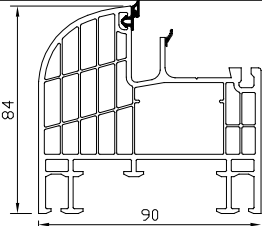
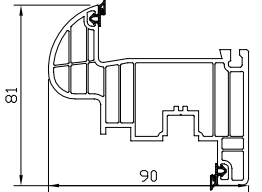
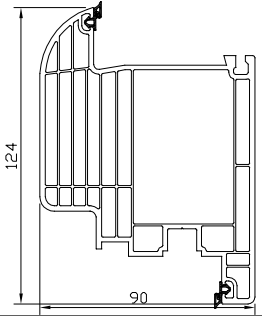
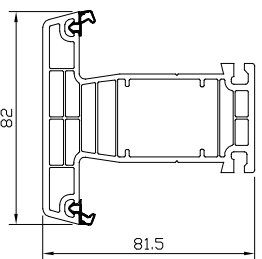
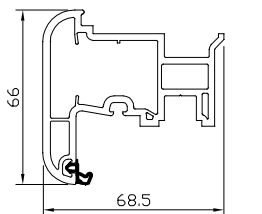
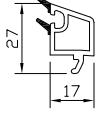
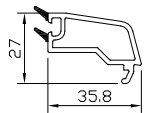

SISTEM 700 - 7 KOMORA

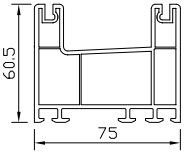
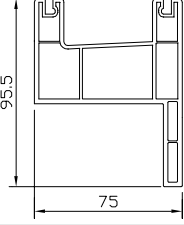
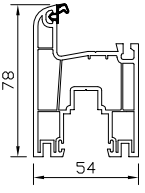
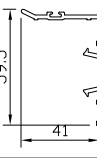
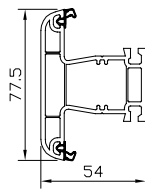

PROFILI	NAZIV PROFILA	Šifra Proiz.	BOJA	Korpa Kom / m	CENA BEZ PDV-A (EURO/m)	CENA SA PDV-OM (EURO/m)
	PVC profil 701 - ram Frame profile (701)		Bela	77 kom / 462m	3.290	3.948
		60801	Bela sa dihtungom	77 kom / 462m	3.420	4.104
		62500	Laminirana sa dihtungom	77 kom / 462m	5.660	6.792
		62506	Antracit spolja sa dihtungom	77 kom / 462m	4.780	5.736
	PVC profil 710 - kriilo prozor Sash profile (710)		Bela	70 kom / 420 m	3.643	4.371
		60802	Bela sa dihtungom	70 kom / 420 m	3.903	4.683
		62501	Laminirana sa dihtungom	70 kom / 420 m	6.415	7.697
		62507	Antracit spolja sa dihtungom	70 kom / 420 m	5.199	6.238
	PVC profil 711 - kriilo vrata Entrance door - sash profile (711)		Bela	49 kom / 294 m	4.465	5.358
		60803	Bela sa dihtungom	49 kom / 294m	4.725	5.670
		62502	Laminirana sa dihtungom	49 kom / 294 m	8.005	9.606
		62508	Antracit spolja sa dihtungom	49 kom / 294 m	6.405	7.686
	PVC profil 720 - stub Mullion profile (720)		Bela	70 kom / 420 m	3.408	4.089
		60804	Bela sa dihtungom	70 kom / 420 m	3.668	4.401
		62503	Laminirana sa dihtungom	70 kom / 420 m	6.228	7.473
		62509	Antracit spolja sa dihtungom	70 kom / 420 m	5.428	6.513
	PVC profil 721 - lažna prečka Sash adapting profile (721)		Bela	91 kom / 546 m	2.468	2.961
		60805	Bela sa dihtungom	91 kom / 546 m	2.598	3.117
		62504	Laminirana sa dihtungom	91 kom / 546 m	4.694	5.632
		62510	Antracit spolja sa dihtungom	91 kom / 546 m	4.022	4.826
	PVC profil 431 - lajsna za staklo Glassbed profile(431)	60206	Bela sa dihtungom	600 kom / 3600m	0.600	0.720
		62505	Laminirana sa dihtungom	600 kom / 3600m	1.176	1.411
	PVC profil 730 - lajsna za staklo Glassbed profile(730)	60812	Bela sa dihtungom	kom / 00m	0.725	0.870
		62511	Laminirana sa dihtungom	kom / 00m	1.525	1.830

SISTEM 800 - 8 KOMORA

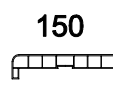
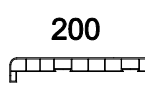
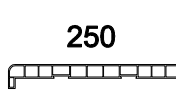
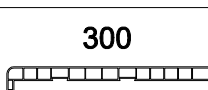
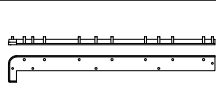
PROFILI	NAZIV PROFILA	Šifra Proiz.	BOJA	Korpa Kom / m	CENA BEZ PDV-A (EURO/m)	CENA SA PDV-OM (EURO/m)
	PVC profil 802 - ram Frame profile(802)		Bela	72 kom / 432m	4.465	5.358
		62400	Bela sa dihtungom	72 kom / 432m	4.595	5.514
	PVC profil 811 - krilo prozora Sash profile (811)		Bela	72 kom / 432m	3.525	4.230
		60707	Bela sa dihtungom	72 kom / 432m	3.785	4.542
	PVC profil 812 - krilo vrata Entrance door sash profile (812)		Bela	36 kom / 216m	5.170	6.204
		60709	Bela sa dihtungom	36 kom / 216m	5.430	6.516
	PVC profil 720 - stub Mullion profile (720)		Bela	36 kom / 216m	3.408	4.089
		60804	Bela sa dihtungom	36 kom / 216m	3.668	4.401
	PVC profil 621 - lažna prečka Sash adapting profile (621)		Bela	117 kom / 702m	2.585	3.102
		60417	Bela sa dihtungom	117 kom / 702m	2.715	3.258
	PVC profil 431 - lajsna za staklo Glassbed profile (431)	60206	Bela sa dihtungom	500 kom / 3000m	0.600	0.720
	PVC profil 730 - lajsna za staklo Glassbed profile (730)	60812	Bela sa dihtungom		0.725	0.870

SISTEM 800 - ŠIBER

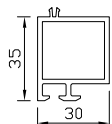
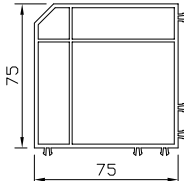
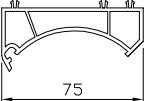
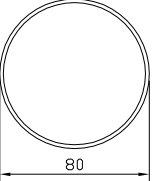
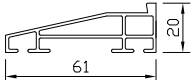
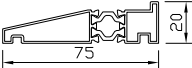
PROFILI	NAZIV PROFILA	Šifra Proiz.	BOJA	Korpa Kom / m	CENA BEZ PDV-A (EURO/m)	CENA SA PDV-OM (EURO/m)
	Profil rama (801)	60700	Bela	77 kom / 462m	2.938	3.525
	Profil rama (801) sa pervajzom	60714	Bela	73 kom / 438m	2.820	3.384
	PVC profil 810 - prošireni ram Frame profile (810)	60706	Bela	90 kom / 540m	2.938	3.525
			Bela sa dihtungom	90 kom / 540m	3.068	3.681
	Profil "L" klizni (820)	60702	Bela	kom / m	0.881	1.058
	PVC profil 320 - stub Mullion profile (320)	60115	Bela	120 kom / 720m	2.233	2.679
			Bela sa dihtungom	120 kom / 720m	2.493	2.991
	PVC profil 330 - lajsna za staklo Glassbed profile (330)	60105	Bela sa dihtungom	840 kom / 4200m	0.475	0.570
	Donja šina za klizni sistem	60713		kom / m	1.250	1.500
	Ukrasna lajsna za opšivanje 23x23mm	62118	Bela	kom / m	0.441	0.529
		62119	Laminirana	kom / m	1.193	1.431
	Podprozorska daska 150	62014	Bela	120 kom / 720m	1.995	2.394
	Podprozorska daska 200	62016	Bela	90 kom / 540m	2.365	2.838
	Podprozorska daska 250	62000	Bela	72 kom / 432m	3.255	3.906
		62002	Laminirana		7.783	9.340
	Podprozorska daska 300	62005	Bela	60 kom / 360m	4.200	5.040
	PVC čep za podprozorsku dasku (300)	61201	Bela	200 par /velika kut.	0.400 par	0.480 par
		61301	Siva		0.400 par	0.480 par
		61401	Braon	50 par /mala kut.	0.400 par	0.480 par
	PVC profil ispune	62100	Bela	150 kom / 900m	1.645	1.974
		62102	Laminirana		5.133	6.160

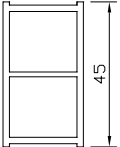
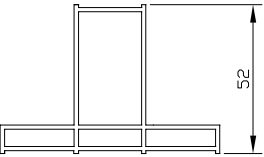
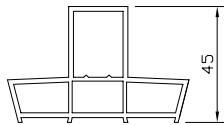
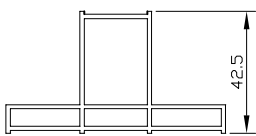
PROFILI	NAZIV PROFILA	Šifra Proiz.	BOJA	Korpa Kom / m	CENA BEZ PDV-A (EURO/m) PRICE (EURO/m)	CENA SA PDV-OM (EURO/m) PRICE (EURO/m)
	PVC profil 402 Proširenje štoka Frame elevation profile (402)	60207	Bela	323 kom / 1938m	1.058	1.269
		60627	Laminirana	323 kom / 1938m	3.027	3.632
	PVC profil 440 ugao 90° 90° Angled box profile (440)	60208	Bela	64 kom / 384m	3.672	4.406
	PVC profil 450 ugao štelujući Angled turning adapter profile (450)	60209	Bela	kom / m	2.203	2.644
		60628	Laminirana	kom / m	5.983	7.180
	PVC profil 460 Ø80 Angled post pipe profile (460)	60210	Bela	kom / m	2.350	2.820
		60629	Laminirana	kom / m	6.094	7.313
	Aluminijumski prag Aluminium sill profile	62104	Nefarbano	kom / m	6.000	7.200
		62105	P L F C	kom / m	7.000	8.400
	Aluminijumski prag sa termoprekidom Aluminium sill profile	62124	P L F C	kom / m	8.500	10.200
	PVC profil 100 spojka za štok Coupling profile (100)	62110	Bela, Braon Lešnik, Siva	kom / m	0.368	0.441
	PVC profil 101 adaptera za podprozorsku dasku Wall conection profile (101)	62103	Bela	350 kom / 2100 m	0.945	1.134
	PVC profil 102 "T" adapter za podprozorsku dasku Wall conection profile "T" (102)	62106	Bela	144 kom	1.638	1.966
	PVC profil 103 "T" adaptera za podproz. dasku, kraći Wall conection profile "T" shorter (103)	62108	Bela	kom / m	1.365	1.638
	PVC profil 104 "T" adaptera za podproz. dasku, kraći za profil 601 Wall conection profile "T" shorter (104)	62101	Bela	kom / m	1.155	1.386

ROLOPLAST CENOVNIK

Br. 11 april 2026

PROFILI

OJAČANJA

OPIS

CENA BEZ PDV-a (EURO/m)

CENA SA PDV-om (EURO/m)

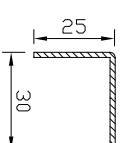
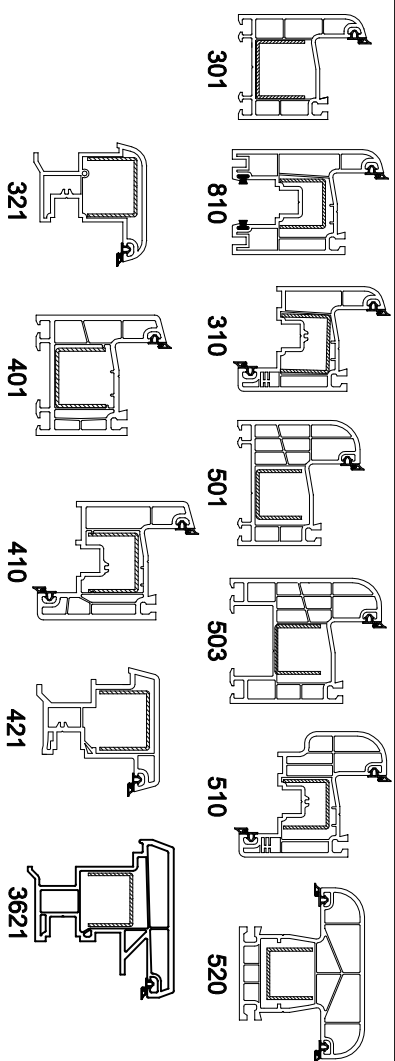

Čelik za štok, krilo,
i lažnu prečku
3k, 5k i 4k i stub 5k
(253025)
Reinforcement profile
(253025)

0.967 1.160

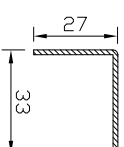
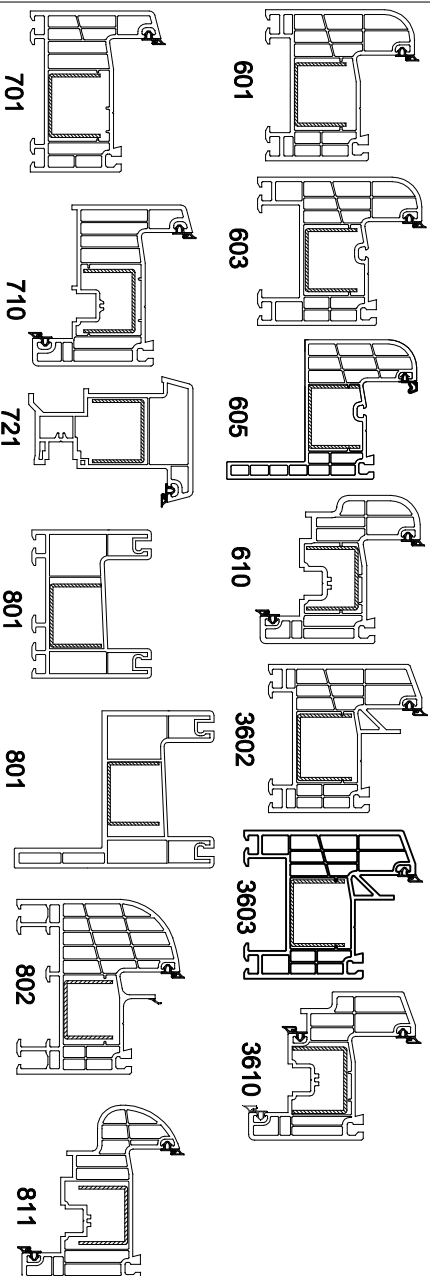

Čelik za štok i krilo 6k
(273327)
Reinforcement profile
(273327)

1.050 1.260

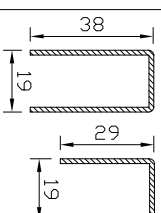
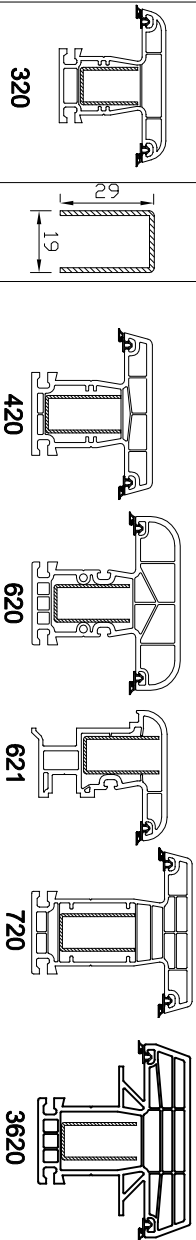

Čelik za stub 4k, 6k
i lažnu prečku (381938)
Reinforcement profile
(381938)
Čelik za stub 3k
(291929)
Reinforcement profile (291929)

1.175 1.410



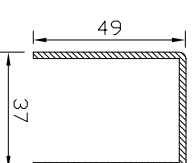
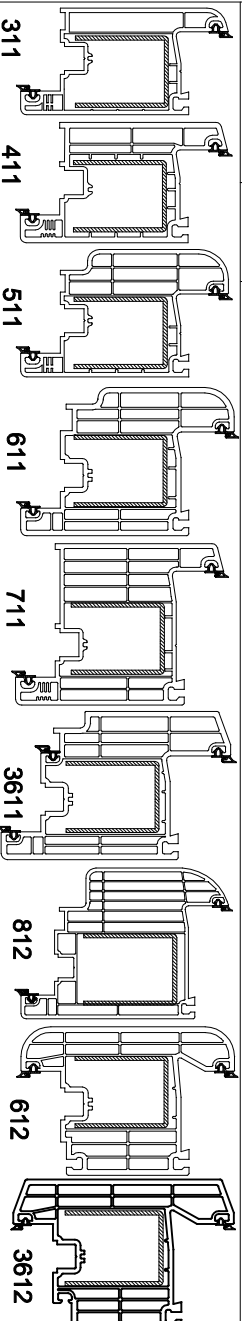



1.542 1.850





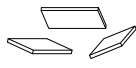
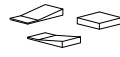

Čelik za krilo vrata 3k, 4k, 5k i 6k
(493749)
Reinforcement profile
(493749)

2.358 2.830

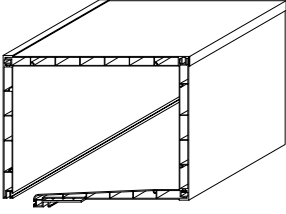
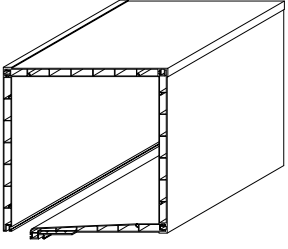
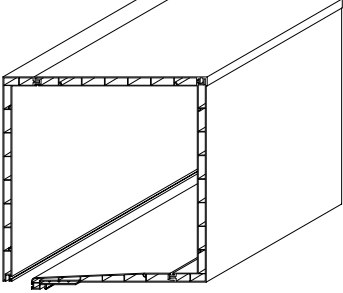
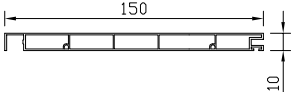
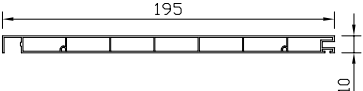
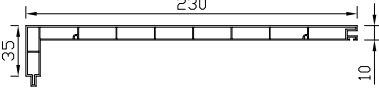
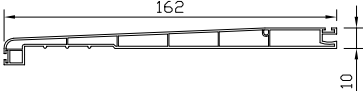
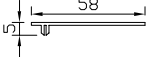
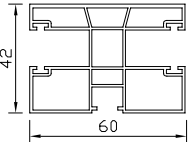
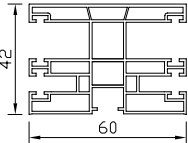
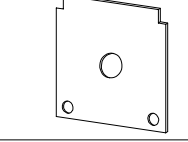
PROFILI	NAZIV PROFILA	Šifra Proiz.	BOJA	Jed.	CENA BEZ PDV-A	CENA SA PDV-OM
	Čep za lažnu prečku (321 i 521) 100 par.	61202	Bela	par.	0.400par	0.480par
	Čep za lažnu prečku (421) 100 par.	61203	Bela	par.	0.400par	0.480par
	Čep za lažnu prečku (621) 100 par.	61204	Bela	par.	0.400par	0.480par
		61304	Siva	par.	0.400par	0.480par
		61404	Braon	par.	0.400par	0.480par
		61219	Antracit	par.	0.400par	0.480par
	Čep za lažnu prečku (721) 50 par.	61214	Bela	par.	0.400par	0.480par
		61216	Siva	par.	0.400par	0.480par
		61215	Braon	par.	0.400par	0.480par
	PVC Spojka Štok (301)-Prag 3k 50 par.	61500	Bela	par.	0.500par	0.600par
	PVC Spojka Štok (401)-Prag 4k 50 par.	61501	Bela	par.	0.500par	0.600par
	PVC Spojka Štok (501)-Prag 5k 50 par.	61505	Bela	par.	0.500par	0.600par
	PVC Spojka Štok (501)-Termo Prag 5k 50 par.	61510	Bela	par.	0.500par	0.600par
	PVC Spojka Štok (601)-Prag 6k 50 par.	61602	Siva	par.	0.500par	0.600par
		61502	Bela	par.	0.500par	0.600par
		61702	Braon	par.	0.500par	0.600par
	PVC Spojka Štok (601)-Termo Prag 6k 50 par.	61511	Bela	par.	0.500par	0.600par
	PVC Spojka Štok (603)-Termo Prag 6k 50 par.	61512	Bela	par.	0.500par	0.600par
	PVC Spojka Štok (603)-Termo Prag 6k 50 par.	61513	Braon	par.	0.500par	0.600par
	PVC Spojka Štok (603)-TermoPrag 6k 50 par.	61514	Siva	par.	0.500par	0.600par
	PVC Spojka Štok (701)-Prag 7k 50 par.	61509	Bela	par.	0.500par	0.600par
	PVC Spojka Štok (701)-Termo Prag 7k 50 par.	61515	Bela	par.	0.500par	0.600par
	PVC Spojka Štok (701)-Termo Prag 7k 50 par.	61516	Braon	par.	0.500par	0.600par
	PVC Spojka Štok (701)-Termo Prag 7k 50 par.	61517	Siva	par.	0.500par	0.600par
	PVC Spojka Štok -Prag 8k 50 par.	61506	Bela	par.	0.500par	0.600par
		61604	Siva	par.	0.500par	0.600par
		61704	Braon	par.	0.500par	0.600par
	Čep za vodu (kondenz otvore) 1paket=100kom 1kutija=2000kom	61205	Bela	pak.	1.800 pak.	2.160 pak.
		61305	Siva	pak.	1.800 pak.	2.160 pak.
		61405	Braon	pak.	1.800 pak.	2.160 pak.
		61218	Antracit	pak.	1.800 pak.	2.160 pak.
	Podloška za šiber 250 kom	61807		kom	0.500	0.600

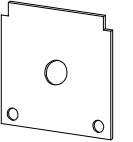

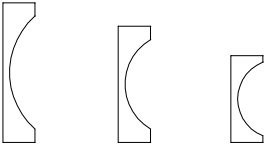

PROFILI	NAZIV PROFILA	Šifra Proiz.	Pakovanje	Jed.	CENA BEZ PDV-A	CENA SA PDV-OM
	Aluminijumska spojnica za stub (320 i 520)	61801		par.	0.600 par	0.720 par
	Aluminijumska spojnica nova za stub (3620)	61816		par.	0.600 par	0.720 par
	Aluminijumska spojnica nova za stub (420),(620) i (720)	61816		par.	0.600 par	0.720 par
	PVC spojnica za stub 320 -520 5 cm komad	61809		kom.	0.180	0.216
	PVC spojnica za stub 320-520 šipka	62125		m.	2.400	2.880
	PVC spojnica za stub 420-620 5 cm komad	61810		kom.	0.180	0.216
	PVC spojnica za stub 420-620 šipka	62126		m.	2.400	2.880
	PVC spojnica za stub 720 5 cm komad	61803		kom.	0.180	0.216
	PVC spojnica za stub 720 šipka	62111		m.	2.400	2.880
	PVC podmetač za staklo 3-5K 1paket=100kom	61905	1paket=100kom	pak.	4.500	5.400
	PVC podmetač za staklo 4-6K 1paket=100kom	61900	1paket=100kom	pak.	4.500	5.400
	PVC podmetač za staklo 7K 1paket=100kom	61903	1paket=100kom	pak.	4.500	5.400
	PVC Kajle za zastakljivanje stolarije RAVNE 1paket=100kom	61901	1paket=100kom	pak.	4.000	4.800
	PVC Kajle za zastakljivanje stolarije KOSE 1paket=100kom	61902	1paket=100kom	pak.	3.000	3.600
	Dichtung za varenje	61103	Na koturu/m	m.	0.100	0.120

PVC kutija (unutrašnja) 150x195	PVC kutija (unutrašnja) 195x195	PVC kutija (unutrašnja) 230x230				
 <p style="text-align: center;">150x195</p> <p>-2 kom Bočni element za PVC kutiju 150 mm -1 kom Gornji element za PVC kutiju 195 mm -1 kom Donji element 162 mm -1 kom Bananica dodatak za spajanje</p>	 <p style="text-align: center;">195x195</p> <p>-2 kom Bočni element za PVC kutiju 195 mm -1 kom Gornji element za PVC kutiju 195 mm -1 kom Donji element 162 mm -1 kom Bananica dodatak za spajanje</p>	 <p style="text-align: center;">230x230</p> <p>-2 kom Bočni element za PVC kutiju 230 mm -1 kom Gornji element za PVC kutiju 195 mm -1 kom Donji element 162 mm -1 kom Bananica dodatak za spajanje</p>				
PROFILI	NAZIV PROFILA	Šifra Proiz.	BOJA	CENA BEZ PDV-A	CENA SA PDV-OM	
	Bočni element za PVC kutiju Dimenzija: 195 x 150 mm	50094	Bela	1.210	1.452	
	Bočni i gornji element za PVC kutiju Dimenzija: 195 x 195 mm Gonji element za PVC kutiju Dimenzija: 150x195 i 230 x 230 mm	50095	Bela	1.364	1.637	
	Bočni element za PVC kutiju Dimenzija: 230 x 230 mm	50096	Bela	1.870	2.244	
	Donji element za PVC kutije 150x195, 195 x 195 mm i 230 x 230 mm	50093	Bela	1.540	1.848	
	Dodatak zaspajanje PVC kutije - bananica	60051	Bela	0.385	0.462	
	PVC vođica za roletne dupla Dimenzije: 42 x 60 mm	71202	Bela Nesečena	1.496	1.795	
	PVC vođica za roletne i komarnik dupla Dimenzije: 42 x 60 mm	71209	Bela Nesečena	1.637	1.964	
		71225	Laminirana Nesečena	3.941	4.729	
		71228	Antracit Nesečena	3.941	4.729	
	Poklopac za PVC kutiju 195 unutrašnji	30084	kom	0.600	0.720	
	Poklopac za PVC kutiju 195 spoljašnji	30085	kom	0.400	0.480	
	PVC spojnica za spajanje stranica	70848	100 kom	0.100	0.120	
	Izolacija za PVC kutije najmanja obračunska mera 1m'	75007	150x195 - 1m'	1.584	1.900	
		75005	195x195 - 1m'	1.709	2.050	
		75006	230x230 - 1m'	2.084	2.500	

ROLOPLAST CENOVNIK

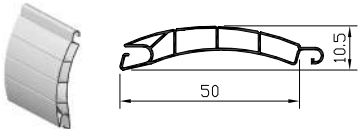
Br. 15

jun 2026

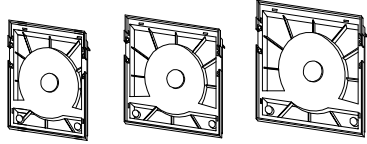
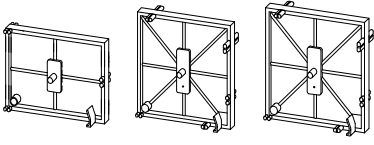



PROFILI	NAZIV PROFILA	Dim.	Jed.	Paket	Korpa Pak/m	Šifra Proiz.	Boja		Cena	
							Nesečena	bez PDV-a	sa PDV-om	
	PVC Letvice za roletne Montira se do širine 1500 mm i max. kvadratura 3.4 m2	50 x 10.5	m2	9.0 m2	28 Pak / 252m2	80306	Bela, Siva	6.820	8.184	
						80307	Drvo	6.820	8.184	
	Spojka za PVC dvokanalnu vođicu 1paket=100kom		pak.	100kom/ pak		61503	Bela	1.800	2.160	
	PVC uvodnik za roletnu za PVC vođicu 42 x 60 100 kom		kom	100 kom		70826	Bela Braon	0.100 0.100	0.120 0.120	
	PVC uvodnik za roletnu i komarnik za PVC vođicu 42 x 60 100 kom		kom	100 kom		70837	Bela Braon	0.100 0.100	0.120 0.120	
	PVC stranica za unutrašnju kutiju bela i braon boja	150x195	kom	70 kom		30066	Bela	1.500	1.800	
		195x195	kom	50 kom		30054	Bela	1.700	2.040	
		230x230	kom	30 kom		30059	Bela	2.200	2.640	
	PVC srednja stranica za unutrašnju kutiju bela boja	150x195	kom	130 kom		30103	Bela	0.900	1.080	
		195x195	kom	100 kom		30058	Bela	1.000	1.200	
		230x230	kom	70 kom		30034	Bela	1.200	1.440	

ROLOPLAST CENOVNIK

Delovi za roletne

Br. 16

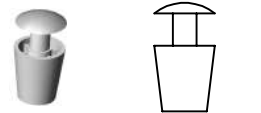
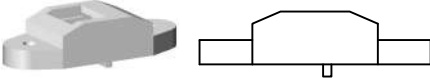
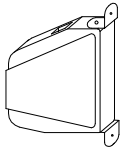
jun 2026

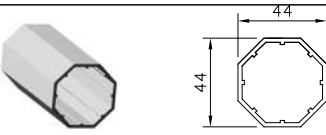
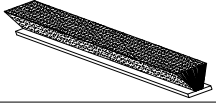
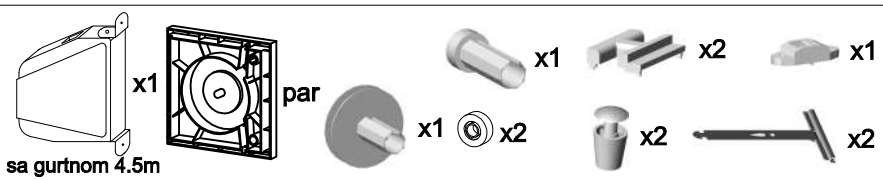
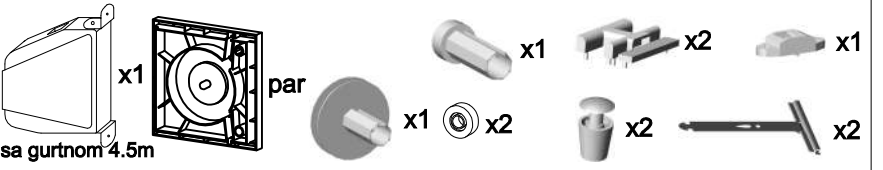
PROFILI	NAZIV PROFILA	Šifra Proiz.	BOJA	Kom	CENA BEZ PDV-A	CENA S PDV-OM
	PVC točak, doboš za namotavanje rolo trake Ø40 100 kom	70031	Crna	kom	0.400	0.480
	PVC završetak na osovina ma Ø40 mm 100 kom	70038	Crna	kom	0.270	0.324
	PVC odbojnik, graničnik za roletnu	70005	Bela Siva Čoko	kom	0.056	0.067
	PVC rolnica sa četkicom za mini rolo traku	70083	Bela	kom	0.1834	0.220
	Automat bez gurtne	70025	Bela	kom	1.608	1.930
			Siva	kom	1.842	2.210
			Čoko	kom	1.842	2.210
	Automat sa gurtnom	70026	Bela	kom	1.900	2.280
			Siva	kom	2.134	2.560
			Čoko	kom	2.134	2.560
	Zakacka letvica za osovину za PVC i Al. letvice 39	70701		kom	0.300	0.360
	Zakacka letvica za osovину za PVC i Al. letvice 43	70702		kom	0.300	0.360
	Kuglicni ležaj metalni Ø28	70029		kom	0.150	0.180
	PVC osovine za roletne Ø44 cena bez rabata	71003		m	0.833	1.000
	Četkice 4.8x500	80635		m	0.075	0.090
	Četkice 4.8x700	80637		m	0.083	0.100
PVC SET PAK		300107	150x195 met.ležaj	kom		
 <p>sa gurtnom 4.5m</p>		300103	195x195 met.ležaj	kom		
		300105	230x230 met.ležaj	kom		
		PVC SET ZA KOMARNIK PAK		300108	150x195 met.ležaj	kom
 <p>sa gurtnom 4.5m</p>		300104	195x195 met.ležaj	kom		
		300106	230x230 met.ležaj	kom		