

# CENOVNIK PROFILA

**roloplast**



**važeći od  
01.03.2026**

## SISTEMSKI METAR

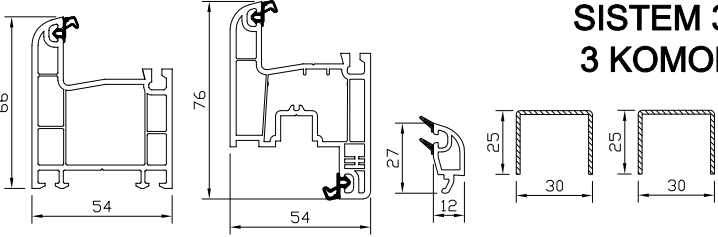
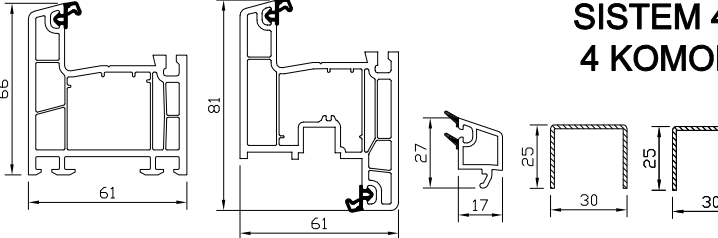
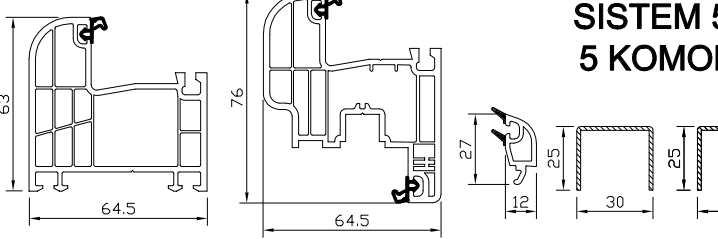
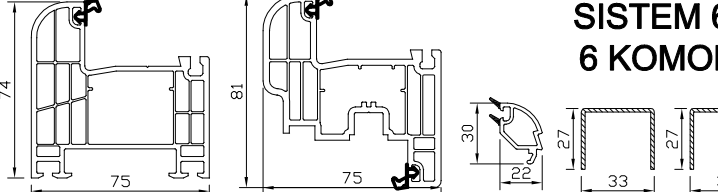
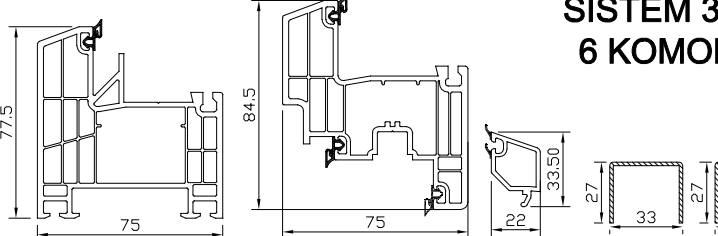
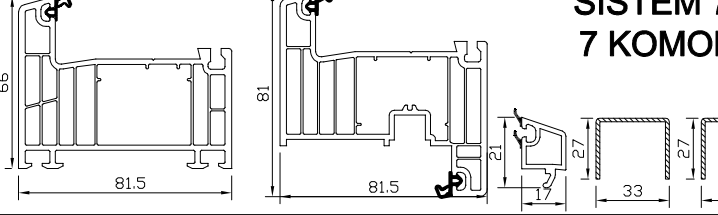
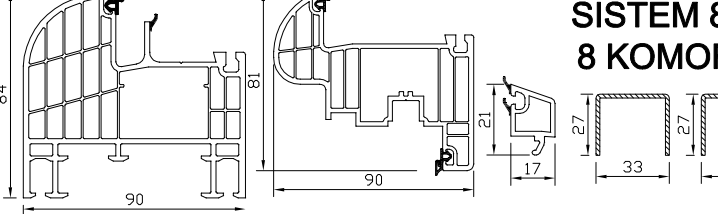
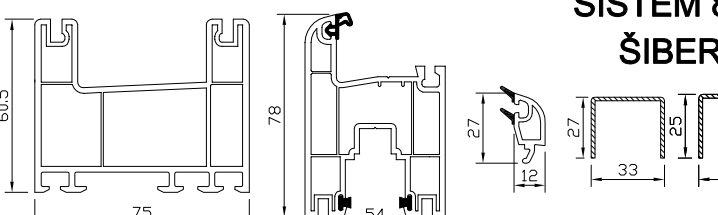
PRIKAZ	BOJA	CENA BEZ PDV-A (EURO/m)	CENA SA PDV-OM (EURO/m)
 <p><b>SISTEM 300 3 KOMORE</b></p>	Bela sa dihtungom	7.3420	8.8104
 <p><b>SISTEM 400 4 KOMORE</b></p>	Bela sa dihtungom	8.9595	10.7514
 <p><b>SISTEM 500 5 KOMORA</b></p>	Bela sa dihtungom	8.0945	9.7134
 <p><b>SISTEM 600 6 KOMORA</b></p>	Bela sa dihtungom	9.2575	11.1090
	Laminirana sa dihtungom	15.7450	18.8940
	Antracit spolja sa dihtungom	12.6310	15.1572
 <p><b>SISTEM 3600 6 KOMORA</b></p>	Bela sa dihtungom	9.4853	11.3823
	Laminirana sa dihtungom	16.0045	19.2054
	Antracit spolja sa dihtungom	12.7405	15.2886
 <p><b>SISTEM 700 7 KOMORA</b></p>	Bela sa dihtungom	9.8850	11.8620
	Laminirana sa dihtungom	15.1005	18.1206
	Antracit spolja sa dihtungom	12.5410	15.0492
 <p><b>SISTEM 800 8 KOMORA</b></p>	Bela sa dihtungom	10.7400	12.8880
 <p><b>SISTEM 800 ŠIBER</b></p>	Bela sa dihtungom i četkicama	7.8335	9.4002

## SISTEM 300 - 3 KOMORA

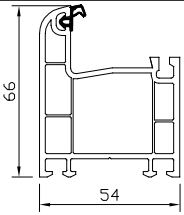
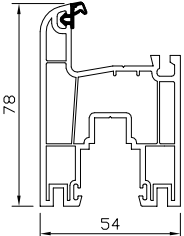
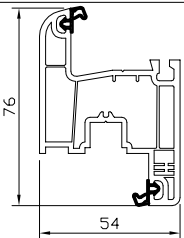
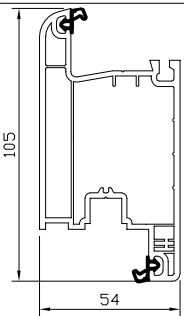
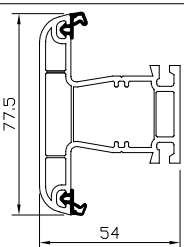
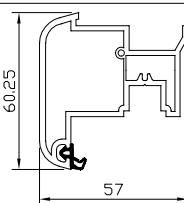
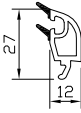
PROFILI	NAZIV PROFILA	Šifra Proiz.	BOJA	Korpa Kom / m	CENA BEZ PDV-A (EURO/m)	CENA SA PDV-OM (EURO/m)
	PVC profil 301 - ram Frame profile (301)	60112	Bela	121 kom / 726m	2.150	2.580
			Bela sa dihtungom	121 kom / 726m	2.280	2.736
	PVC profil 810 - prošireni ram Frame profile (810)	60706	Bela	99 kom / 594m	2.688	3.225
			Bela sa dihtungom	99 kom / 594m	2.818	3.381
	PVC profil 310 - krilo prozora Sash profile (310)	60113	Bela	108 kom / 648m	2.043	2.451
			Bela sa dihtungom	108 kom / 648m	2.303	2.763
	PVC profil 311 - krilo vrata Entrance door sash profile (311)	60114	Bela	77 kom / 462m	2.688	3.225
			Bela sa dihtungom	77 kom / 462m	2.948	3.537
	PVC profil 320 - stub Mullion profile (320)	60115	Bela	121 kom / 726m	2.043	2.451
			Bela sa dihtungom	121 kom / 726m	2.303	2.763
	PVC profil 321 - lažna prečka Sash adapting profile (321)	60116	Bela	154 kom / 924m	1.720	2.064
			Bela sa dihtungom	154 kom / 924m	1.850	2.220
	PVC profil 330 - lajsna za staklo Glassbed profile (330)	60105	Bela sa dihtungom	840 kom / 5040m	0.428	0.513

## SISTEM 400 - 4 KOMORA

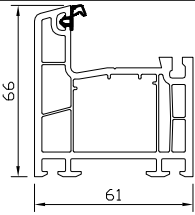
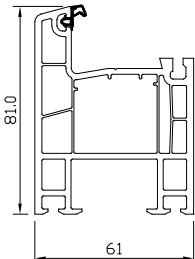
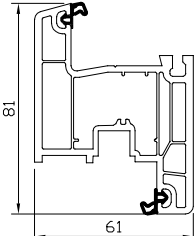
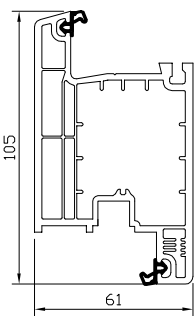
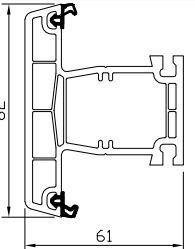
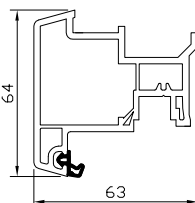
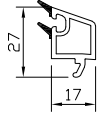
PROFILI	NAZIV PROFILA	Šifra Proiz.	BOJA	Korpa Kom / m	CENA BEZ PDV-A (EURO/m)	CENA SA PDV-OM (EURO/m)
	PVC profil 401 - ram Frame profile (401)		Bela	110 kom / 660m	2.795	3.354
		60212	Bela sa dihtungom	110 kom / 660m	2.925	3.510
	PVC profil 403 - ram Frame profile (403)		Bela	72 kom / 432m	2.903	3.483
		60213	Bela sa dihtungom	72 kom / 432m	3.163	3.795
	PVC profil 410 - krilo prozora Sash profile (410)		Bela	100 kom / 600m	2.903	3.483
		60214	Bela sa dihtungom	100 kom / 600m	3.163	3.795
	PVC profil 411 - krilo vrata Entrance door sash profile (411)		Bela	72 kom / 432m	3.440	4.128
		60215	Bela sa dihtungom	72 kom / 594m	3.700	4.440
	PVC profil 420 - stub Mullion profile (420)		Bela	99 kom / 594m	2.580	3.096
		60216	Bela sa dihtungom	99 kom / 432m	2.840	3.408
	PVC profil 421 - lažna prečka Sash adapting profile (421)		Bela	112 kom / 672m	2.150	2.580
		60217	Bela sa dihtungom	112 kom / 672m	2.280	2.736
	PVC profil 431 - lajsna za staklo Glassbed profile (431)	60206	Bela	640 kom / 3600m	0.540	0.648

## SISTEM 500 - 5 KOMORA

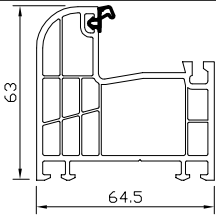
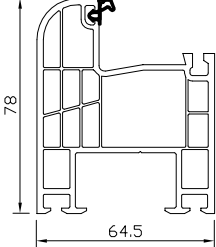
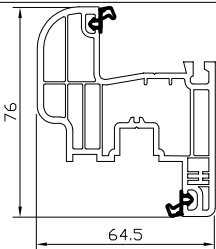
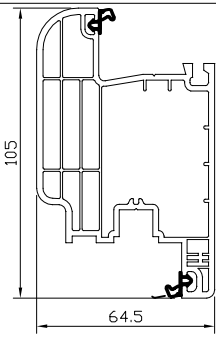
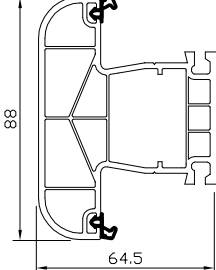
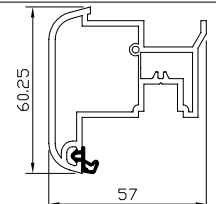
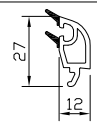
PROFILI	NAZIV PROFILA	Šifra Proiz.	BOJA	Korpa Kom / m	CENA BEZ PDV-A (EURO/m)	CENA SA PDV-OM (EURO/m)
	PVC profil 501 - ram Frame profile (501)	60312	Bela	108 kom / 648m	2.365	2.838
			Bela sa dihtungom	108 kom / 648m	2.495	2.994
	PVC profil 503 - prošireni ram Frame profile (503)	60316	Bela	81 kom / 486m	2.795	3.354
			Bela sa dihtungom	81 kom / 486m	2.925	3.510
	PVC profil 510 - krilo prozora Sash profile (510)	60313	Bela	99 kom / 594m	2.580	3.096
			Bela sa dihtungom	99 kom / 594m	2.840	3.408
	PVC profil 511 - krilo vrata Entrance door sash profile (511)	60319	Bela	63 kom / 376m	3.010	3.612
			Bela sa dihtungom	63 kom / 376m	3.270	3.924
	PVC profil 520 - stub Mullion profile (520)	60318	Bela	81 kom / 486m	2.795	3.354
			Bela sa dihtungom	81 kom / 486m	3.055	3.666
	PVC profil 321 - lažna prečka Sash adapting profile 321	60116	Bela	160 kom / 960m	1.720	2.064
			Bela sa dihtungom	160 kom / 960m	1.850	2.220
	PVC profil 330 -lajsna za staklo Glassbed profile 330	60105	Bela sa dihtungom	840 kom / 4200m	0.428	0.513

## SISTEM 600 - 6 KOMORA

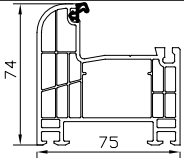
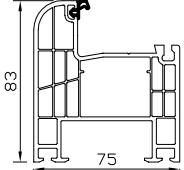
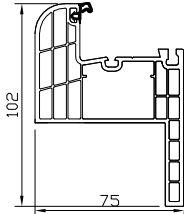
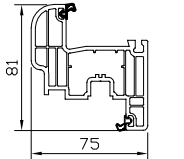
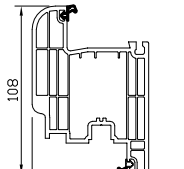
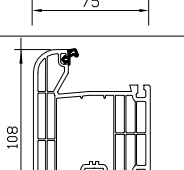
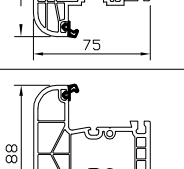
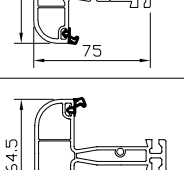
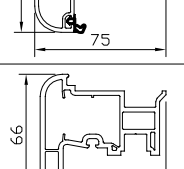
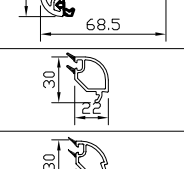
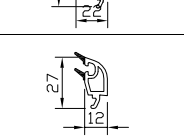
PROFILI	NAZIV PROFILA	Šifra Proiz.	BOJA	Korpa Kom / m	CENA BEZ PDV-A (EURO/m)	CENA SA PDV-OM (EURO/m)
	PVC profil 601 - ram Frame profile (601)		Bela	80 kom / 480m	2.903	3.483
		60412	Bela sa dihtungom	80 kom / 480m	3.033	3.639
	PVC profil 603 - prošireni ram Frame profile (603)		Bela	72 kom / 432m	3.268	3.922
		60418	Bela sa dihtungom	72 kom / 432m	3.398	4.078
		60626	Laminirana sa dihtungom	72 kom / 432m	6.182	7.418
	PVC profil 605 - ram sa pervajzom Frame profile (605)	60635	Antracit spolja sa dihtungom	72 kom / 432m	5.094	6.113
		60424	Bela sa dihtungom	64 kom / 384m	2.925	3.510
	PVC profil 605 - ram sa pervajzom Frame profile (605)	60634	Laminirana sa dihtungom	64 kom / 384m	5.789	6.947
			Bela	64 kom / 384m	2.795	3.354
	PVC profil 610 - krilo prozora Sash profile (610)	60413	Bela sa dihtungom	80 kom / 480m	3.163	3.795
		60620	Laminirana sa dihtungom	80 kom / 480m	5.723	6.867
		60636	Antracit spolja sa dihtungom	80 kom / 480m	4.475	5.369
	PVC profil 611 - krilo vrata Entrance door - sash profile (611)		Bela	56 kom / 336m	4.085	4.902
		60414	Bela sa dihtungom	56 kom / 336m	4.345	5.214
		60621	Laminirana sa dihtungom	56 kom / 336m	7.785	9.342
	PVC profil 612 - krilo vrata za spoljašnje otvaranje Entrance door sash profile for external opening (612)	60639	Antracit spolja sa dihtungom	56 kom / 336m	6.105	7.326
			Bela	56 kom / 336m	4.193	5.031
	PVC profil 612 - krilo vrata za spoljašnje otvaranje Entrance door sash profile for external opening (612)	60415	Bela sa dihtungom	56 kom / 336m	4.453	5.343
		60630	Laminirana sa dihtungom	56 kom / 336m	7.893	9.471
			Bela	72 kom / 432m	3.548	4.257
	PVC profil 620 - stub Mullion profile (620)	60416	Bela sa dihtungom	72 kom / 432m	3.808	4.569
		60622	Laminirana sa dihtungom	72 kom / 432m	6.656	7.987
		60637	Antracit spolja sa dihtungom	72 kom / 432m	5.856	7.027
	PVC profil 622 - stub Mullion profile (622)		Bela	112 kom / 672m	2.043	2.451
		60419	Bela sa dihtungom	112 kom / 672m	2.303	2.763
		60633	Laminirana sa dihtungom	112 kom / 672m	4.399	5.278
	PVC profil 621 - lažna prečka Sash adapting profile (621)	60417	Bela sa dihtungom	117 kom / 702m	2.365	2.838
		60623	Laminirana sa dihtungom	117 kom / 702m	4.575	5.490
		60638	Antracit spolja sa dihtungom	117 kom / 702m	3.919	4.703
	PVC profil 630 - lajsna za staklo Glassbed profile (630)	60406	Bela sa dihtungom	500 kom / 3000m	0.653	0.783
		60606	Laminirana sa dihtungom		1.341	1.609
	PVC profil 631 - lajsna za staklo Glassbed profile (631)	60420	Bela sa dihtungom	560kom / 3360m	0.563	0.675
	PVC profil 330 - lajsna za troslojno staklo Glassbed profile (330)	60105	Bela sa dihtungom	840 kom / 5040m	0.428	0.513
		60118	Laminirana sa dihtungom		1.154	1.385

## SISTEM 3600 - 6 KOMORA

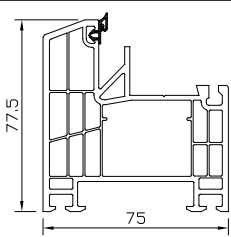
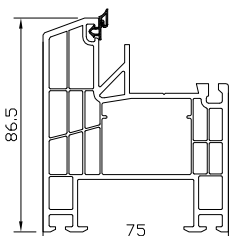
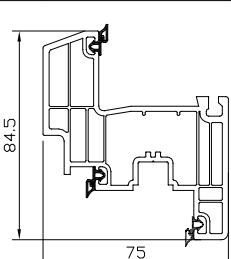
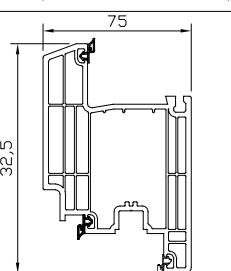
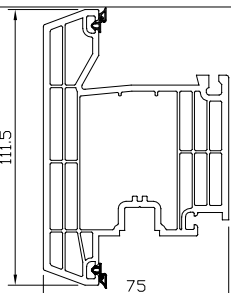
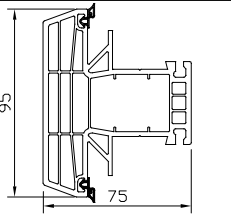
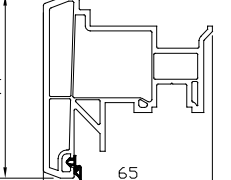
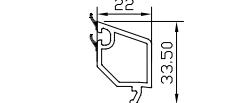
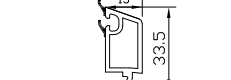
PROFILI	NAZIV PROFILA	Šifra Proiz.	BOJA	Korpa Kom / m	CENA BEZ PDV-A (EURO/m)	CENA SA PDV-OM (EURO/m)
	PVC profil 3602 - ram Frame profile (3602)		Bela	80 kom / 480m	3.085	3.702
		62601	Bela sa dihtungom	80 kom / 480m	3.215	3.858
	PVC profil 3603 - ram Frame profile (3603)		Bela	64 kom / 512m	3.333	3.999
		62602	Bela sa dihtungom	64 kom / 512m	3.463	4.155
		62701	Laminirana sa dihtungom	64 kom / 512m	6.375	7.649
		60635	Antracit spolja sa dihtungom	64 kom / 512m	5.223	6.267
	PVC profil 3610 - krilo prozora Sash profile (3610)		Bela	72 kom / 432m	2.903	3.483
		62603	Bela sa dihtungom	72 kom / 432m	3.163	3.795
		62702	Laminirana sa dihtungom	72 kom / 432m	5.787	6.944
			Antracit spolja sa dihtungom	72 kom / 432m	4.411	5.293
	PVC profil 3611 - krilo vrata Entrance door sash profile (3611)		Bela	48 kom / 288m	4.236	5.083
		62604	Bela sa dihtungom	48 kom / 288m	4.496	5.395
		62703	Laminirana sa dihtungom	48 kom / 288m	8.432	10.118
			Antracit spolja sa dihtungom	48 kom / 288m	6.576	7.891
	PVC profil 3612 - krilo vrata za spoljašnje otvaranje Entrance door sash profile for external opening (3612)		Bela	56 kom / 336m	4.257	5.108
		62605	Bela sa dihtungom	56 kom / 336m	4.517	5.420
		62704	Laminirana sa dihtungom	56 kom / 336m	7.957	9.548
	PVC profil 3620 - stub Mullion profile (3620)		Bela	72 kom / 432m	4.300	5.160
		62606	Bela sa dihtungom	72 kom / 432m	4.560	5.472
		62704	Laminirana sa dihtungom	72 kom / 432m	7.600	9.120
		60637	Antracit spolja sa dihtungom	72 kom / 432m	6.800	8.160
	PVC profil 3621 - lažna prečka Sash adapting profile (3621)	62607	Bela sa dihtungom	117 kom / 702m	2.419	2.903
		62705	Laminirana sa dihtungom	117 kom / 702m	4.805	5.766
		60638	Antracit spolja sa dihtungom	117 kom / 702m	4.149	4.979
			Bela	117 kom / 702m	2.419	2.903
	PVC profil 3630 - lajsna za staklo Glassbed profile (3630)	62608	Bela sa dihtungom	500 kom / 3000m	0.608	0.729
		62705	Laminirana sa dihtungom	500 kom / 3000m	1.344	1.612
	PVC profil 3631 - lajsna za troslojno staklo Glassbed profile (3631)	62617	Bela sa dihtungom	500 kom / 3000m	0.563	0.675
			Laminirana sa dihtungom	500 kom / 3000m	1.187	1.424



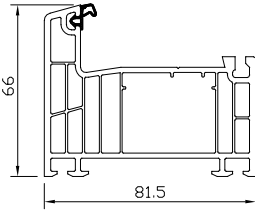
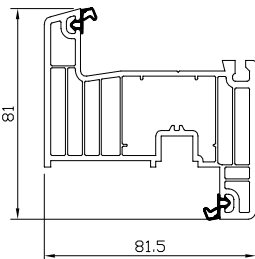
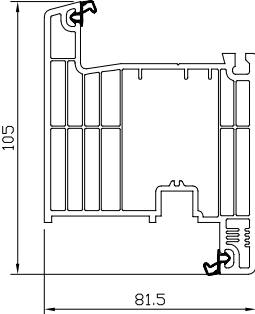
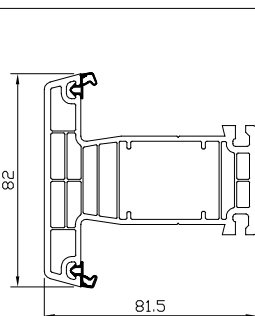
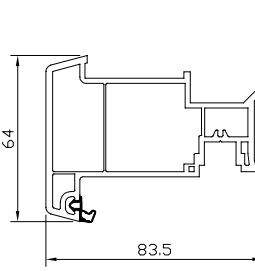
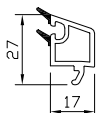
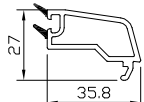

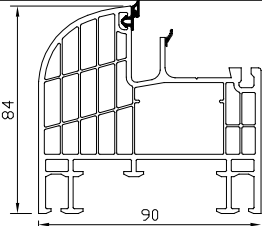
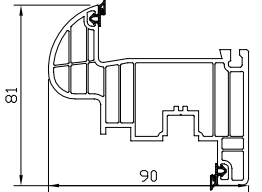
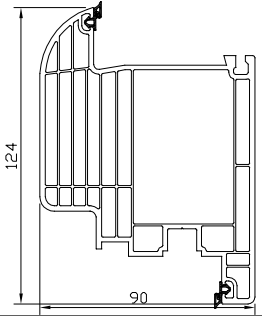
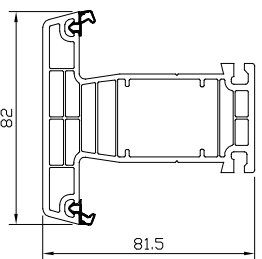
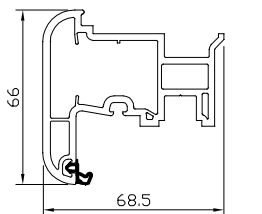
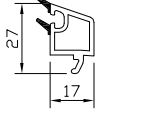
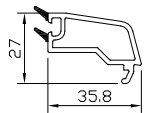

## SISTEM 700 - 7 KOMORA

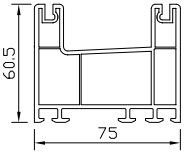
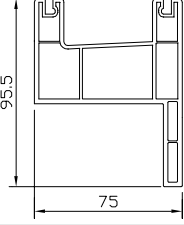
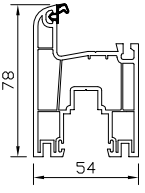
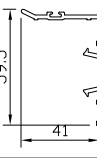
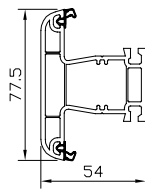

PROFILI	NAZIV PROFILA	Šifra Proiz.	BOJA	Korpa Kom / m	CENA BEZ PDV-A (EURO/m)	CENA SA PDV-OM (EURO/m)
	PVC profil 701 - ram Frame profile (701)		Bela	77 kom / 462m	3.010	3.612
		60801	Bela sa dihtungom	77 kom / 462m	3.140	3.768
		62500	Laminirana sa dihtungom	77 kom / 462m	5.380	6.456
		62506	Antracit spolja sa dihtungom	77 kom / 462m	4.500	5.400
	PVC profil 710 - krilo prozor Sash profile (710)		Bela	70 kom / 420 m	3.333	3.999
		60802	Bela sa dihtungom	70 kom / 420 m	3.593	4.311
		62501	Laminirana sa dihtungom	70 kom / 420 m	6.105	7.325
		62507	Antracit spolja sa dihtungom	70 kom / 420 m	4.889	5.866
	PVC profil 711 - krilo vrata Entrance door - sash profile (711)		Bela	49 kom / 294 m	4.085	4.902
		60803	Bela sa dihtungom	49 kom / 294m	4.345	5.214
		62502	Laminirana sa dihtungom	49 kom / 294 m	7.625	9.150
		62508	Antracit spolja sa dihtungom	49 kom / 294 m	6.025	7.230
	PVC profil 720 - stub Mullion profile (720)		Bela	70 kom / 420 m	3.118	3.741
		60804	Bela sa dihtungom	70 kom / 420 m	3.378	4.053
		62503	Laminirana sa dihtungom	70 kom / 420 m	5.938	7.125
		62509	Antracit spolja sa dihtungom	70 kom / 420 m	5.138	6.165
	PVC profil 721 - lažna prečka Sash adapting profile (721)		Bela	91 kom / 546 m	2.258	2.709
		60805	Bela sa dihtungom	91 kom / 546 m	2.388	2.865
		62504	Laminirana sa dihtungom	91 kom / 546 m	4.484	5.380
		62510	Antracit spolja sa dihtungom	91 kom / 546 m	3.812	4.574
	PVC profil 431 - lajsna za staklo Glassbed profile(431)	60206	Bela sa dihtungom	600 kom / 3600m	0.540	0.648
		62505	Laminirana sa dihtungom	600 kom / 3600m	1.116	1.339
	PVC profil 730 - lajsna za staklo Glassbed profile(730)	60812	Bela sa dihtungom	kom / 00m	0.653	0.783
		62511	Laminirana sa dihtungom	kom / 00m	1.453	1.743

## SISTEM 800 - 8 KOMORA

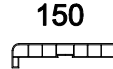
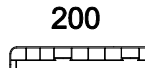
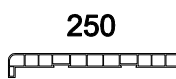
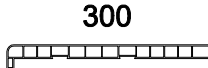
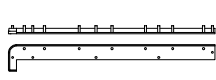
PROFILI	NAZIV PROFILA	Šifra Proiz.	BOJA	Korpa Kom / m	CENA BEZ PDV-A (EURO/m)	CENA SA PDV-OM (EURO/m)
	PVC profil 802 - ram Frame profile(802)		Bela	72 kom / 432m	4.085	4.902
		62400	Bela sa dihtungom	72 kom / 432m	4.215	5.058
	PVC profil 811 - krilo prozora Sash profile (811)		Bela	72 kom / 432m	3.225	3.870
		60707	Bela sa dihtungom	72 kom / 432m	3.485	4.182
	PVC profil 812 - krilo vrata Entrance door sash profile (812)		Bela	36 kom / 216m	4.730	5.676
		60709	Bela sa dihtungom	36 kom / 216m	4.990	5.988
	PVC profil 720 - stub Mullion profile (720)		Bela	36 kom / 216m	3.118	3.741
		60804	Bela sa dihtungom	36 kom / 216m	3.378	4.053
	PVC profil 621 - lažna prečka Sash adapting profile (621)		Bela	117 kom / 702m	2.365	2.838
		60417	Bela sa dihtungom	117 kom / 702m	2.495	2.994
	PVC profil 431 - lajsna za staklo Glassbed profile (431)	60206	Bela sa dihtungom	500 kom / 3000m	0.540	0.648
	PVC profil 730 - lajsna za staklo Glassbed profile (730)	60812	Bela sa dihtungom		0.653	0.783

## SISTEM 800 - ŠIBER

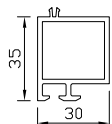
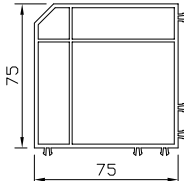
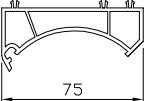
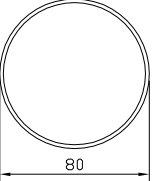
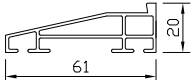
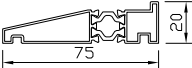
PROFILI	NAZIV PROFILA	Šifra Proiz.	BOJA	Korpa Kom / m	CENA BEZ PDV-A (EURO/m)	CENA SA PDV-OM (EURO/m)
	Profil rama (801)	60700	Bela	77 kom / 462m	2.688	3.225
	Profil rama (801) sa pervajzom	60714	Bela	73 kom / 438m	2.580	3.096
	PVC profil 810 - prošireni ram Frame profile (810)	60706	Bela	90 kom / 540m	2.688	3.225
			Bela sa dihtungom	90 kom / 540m	2.818	3.381
	Profil "L" klizni (820)	60702	Bela	kom / m	0.806	0.968
	PVC profil 320 - stub Mullion profile (320)	60115	Bela	120 kom / 720m	2.043	2.451
			Bela sa dihtungom	120 kom / 720m	2.303	2.763
	PVC profil 330 - lajsna za staklo Glassbed profile (330)	60105	Bela sa dihtungom	840 kom / 4200m	0.428	0.513
	Donja šina za klizni sistem	60713		kom / m	1.250	1.500
	Ukrasna lajsna za opšivanje 23x23mm	62118	Bela	kom / m	0.403	0.484
		62119	Laminirana	kom / m	1.155	1.386
	Podprozorska daska 150	62014	Bela	120 kom / 720m	1.805	2.166
	Podprozorska daska 200	62016	Bela	90 kom / 540m	2.139	2.567
	Podprozorska daska 250	62000	Bela	72 kom / 432m	2.945	3.534
		62002	Laminirana		7.473	8.968
	Podprozorska daska 300	62005	Bela	60 kom / 360m	3.800	4.560
	PVC čep za podprozorsku dasku (300)	61201	Bela	200 par /velika kut.	0.280 par	0.336 par
		61301	Siva		0.280 par	0.336 par
		61401	Braon	50 par /mala kut.	0.280 par	0.336 par
	PVC profil ispune	62100	Bela	150 kom / 900m	1.505	1.806
		62102	Laminirana		4.993	5.992

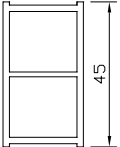
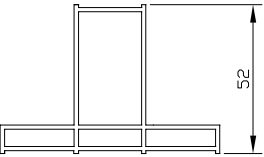
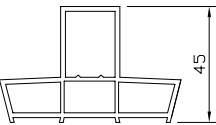
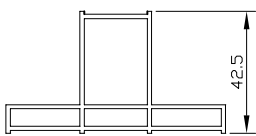
PROFILI	NAZIV PROFILA	Šifra Proiz.	BOJA	Korpa Kom / m	CENA BEZ PDV-A (EURO/m) PRICE (EURO/m)	CENA SA PDV-OM (EURO/m) PRICE (EURO/m)
	PVC profil 402 Proširenje štoka Frame elevation profile (402)	60207	Bela	323 kom / 1938m	0.968	1.161
		60627	Laminirana	323 kom / 1938m	2.869	3.443
	PVC profil 440 ugao 90° 90° Angled box profile (440)	60208	Bela	64 kom / 384m	3.359	4.031
	PVC profil 450 ugao štelujući Angled turning adapter profile (450)	60209	Bela	kom / m	2.016	2.419
		60628	Laminirana	kom / m	5.655	6.786
	PVC profil 460 Ø80 Angled post pipe profile (460)	60210	Bela	kom / m	2.150	2.580
		60629	Laminirana	kom / m	5.894	7.073
	Aluminijumski prag Aluminium sill profile	62104	Nefarbano	kom / m	6.000	7.200
		62105	P L F C	kom / m	7.000	8.400
	Aluminijumski prag sa termoprekidom Aluminium sill profile	62124	P L F C	kom / m	8.500	10.200
	PVC profil 100 spojka za štok Coupling profile (100)	62110	Bela, Braon Lešnik, Siva	kom / m	0.333	0.399
	PVC profil 101 adaptera za podprozorsku dasku Wall conection profile (101)	62103	Bela	350 kom / 2100 m	0.855	1.026
	PVC profil 102 "T" adapter za podprozorsku dasku Wall conection profile "T" (102)	62106	Bela	144 kom	1.482	1.778
	PVC profil 103 "T" adaptera za podproz. dasku, kraći Wall conection profile "T" shorter (103)	62108	Bela	kom / m	1.235	1.482
	PVC profil 104 "T" adaptera za podproz. dasku, kraći za profil 601 Wall conection profile "T" shorter (104)	62101	Bela	kom / m	1.007	1.208

# ROLOPLAST CENOVNIK

Br. 11 april 2026

PROFILI

OJAČANJA

OPIS

CENA BEZ PDV-a (EURO/m)

CENA SA PDV-om (EURO/m)

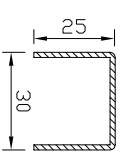
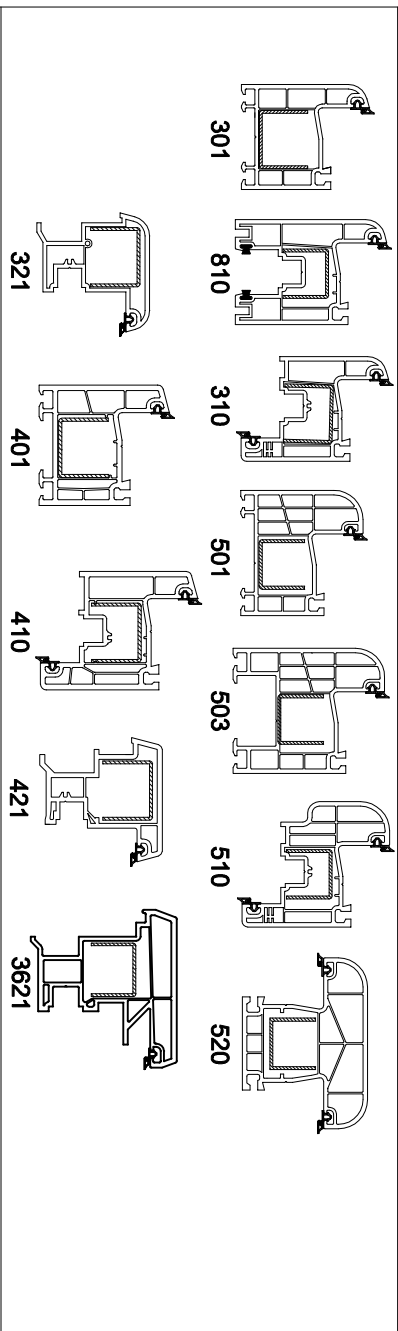

Čelik za štok, krilo,  
i lažnu prečku  
3k, 5k i 4k i stub 5k  
(253025)  
Reinforcement profile  
(253025)

0.967 1.160

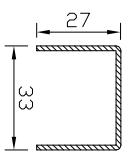
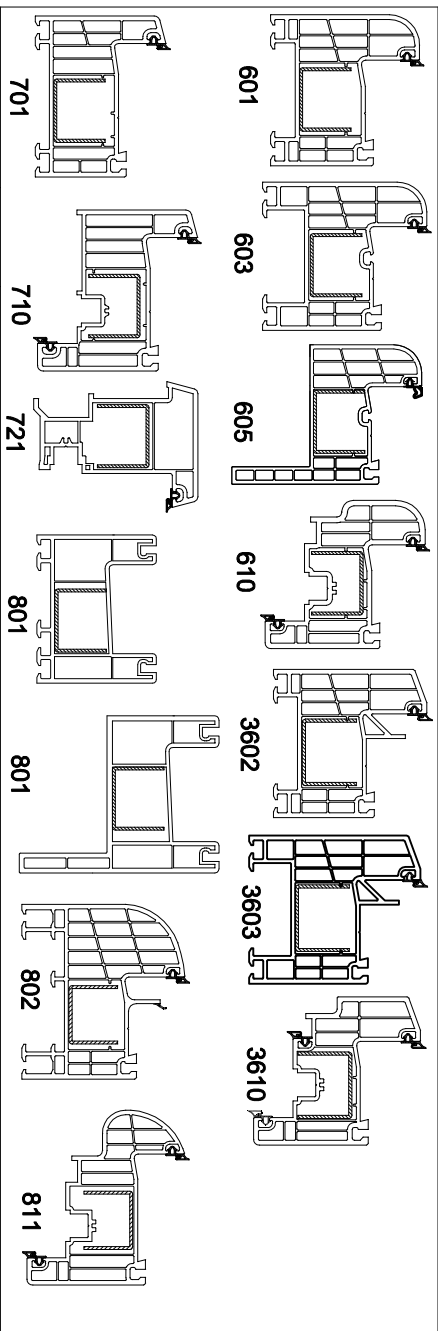

Čelik za štok i krilo 6k  
(273327)  
Reinforcement profile  
(273327)

1.050 1.260

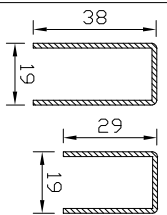
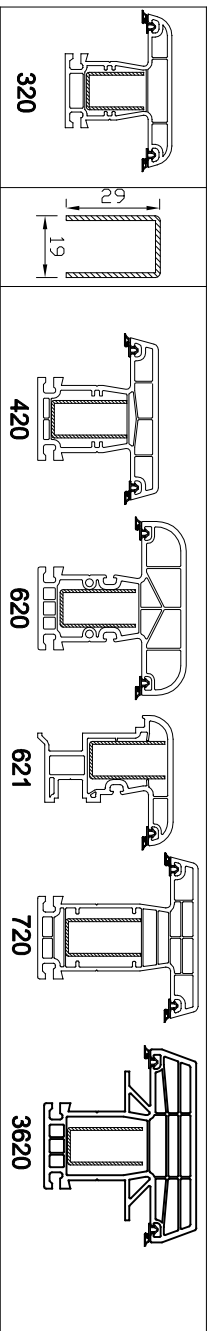

Čelik za stub 4k, 6k  
i lažnu prečku (381938)  
Reinforcement profile  
(381938)  
Čelik za stub 3k  
(291929)  
Reinforcement profile (291929)

1.175 1.410



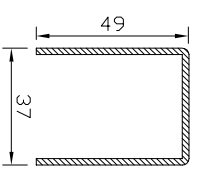
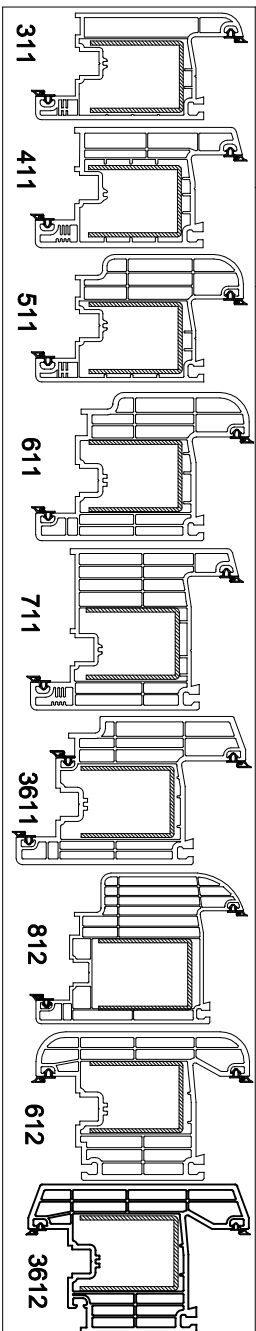





1.542 1.850





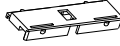
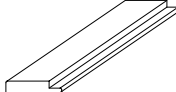
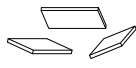

Čelik za krilo vrata 3k, 4k, 5k i 6k  
(493749)  
Reinforcement profile  
(493749)

2.358 2.830

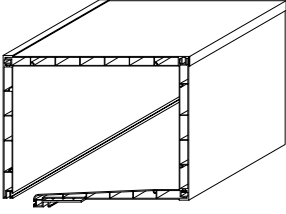
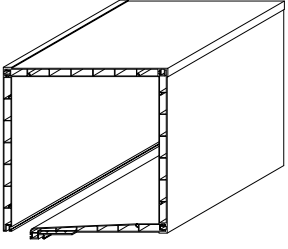
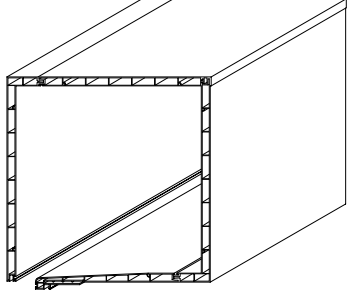
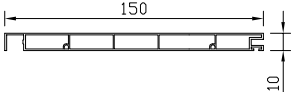
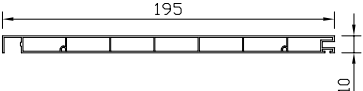
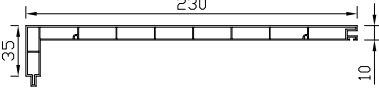
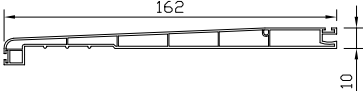
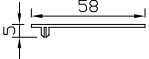
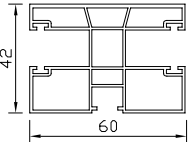
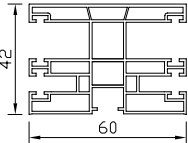
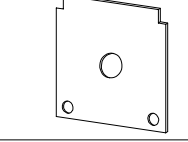
PROFILI	NAZIV PROFILA	Šifra Proiz.	BOJA	Jed.	CENA BEZ PDV-A	CENA SA PDV-OM
	Čep za lažnu prečku (321 i 521) 100 par.	61202	Bela	par.	0.250par	0.300par
	Čep za lažnu prečku (421) 100 par.	61203	Bela	par.	0.250par	0.300par
	Čep za lažnu prečku (621) 100 par.	61204	Bela	par.	0.250par	0.300par
		61304	Siva	par.	0.250par	0.300par
		61404	Braon	par.	0.250par	0.300par
		61219	Antracit	par.	0.250par	0.300par
	Čep za lažnu prečku (721) 50 par.	61214	Bela	par.	0.250par	0.300par
		61216	Siva	par.	0.250par	0.300par
		61215	Braon	par.	0.250par	0.300par
	PVC Spojka Štok (301)-Prag 3k 50 par.	61500	Bela	par.	0.400par	0.480par
	PVC Spojka Štok (401)-Prag 4k 50 par.	61501	Bela	par.	0.400par	0.480par
	PVC Spojka Štok (501)-Prag 5k 50 par.	61505	Bela	par.	0.400par	0.480par
	PVC Spojka Štok (501)-Termo Prag 5k 50 par.	61510	Bela	par.	0.400par	0.480par
	PVC Spojka Štok (601)-Prag 6k 50 par.	61602	Siva	par.	0.400par	0.480par
		61502	Bela	par.	0.400par	0.480par
		61702	Braon	par.	0.400par	0.480par
	PVC Spojka Štok (601)-Termo Prag 6k 50 par.	61511	Bela	par.	0.400par	0.480par
	PVC Spojka Štok (603)-Termo Prag 6k 50 par.	61512	Bela	par.	0.400par	0.480par
	PVC Spojka Štok (603)-Termo Prag 6k 50 par.	61513	Braon	par.	0.400par	0.480par
	PVC Spojka Štok (603)-Termo Prag 6k 50 par.	61514	Siva	par.	0.400par	0.480par
	PVC Spojka Štok (701)-Prag 7k 50 par.	61509	Bela	par.	0.400par	0.480par
	PVC Spojka Štok (701)-Termo Prag 7k 50 par.	61515	Bela	par.	0.400par	0.480par
	PVC Spojka Štok (701)-Termo Prag 7k 50 par.	61516	Braon	par.	0.400par	0.480par
	PVC Spojka Štok (701)-Termo Prag 7k 50 par.	61517	Siva	par.	0.400par	0.480par
	PVC Spojka Štok -Prag 8k 50 par.	61506	Bela	par.	0.400par	0.480par
		61604	Siva	par.	0.400par	0.480par
		61704	Braon	par.	0.400par	0.480par
	Čep za vodu (kondenz otvore) 1 paket=100kom 1kutija=2000kom	61205	Bela	pak.	1.400 pak.	1.680 pak.
		61305	Siva	pak.	1.400 pak.	1.680 pak.
		61405	Braon	pak.	1.400 pak.	1.680 pak.
		61218	Antracit	pak.	1.400 pak.	1.680 pak.
	Podloška za šiber 250 kom	61807		kom	0.280	0.336

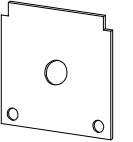

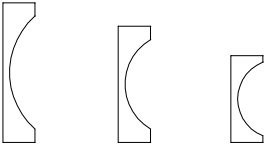

PROFILI	NAZIV PROFILA	Šifra Proiz.	Pakovanje	Jed.	CENA BEZ PDV-A	CENA SA PDV-OM
	Aluminijumska spojnica za stub (320 i 520)	61801		par.	0.600 par	0.720 par
	Aluminijumska spojnica nova za stub (3620)	61816		par.	0.600 par	0.720 par
	Aluminijumska spojnica nova za stub (420),(620) i (720)	61816		par.	0.600 par	0.720 par
	PVC spojnica za stub 320 -520 5 cm komad	61809		kom.	0.180	0.216
	PVC spojnica za stub 320-520 šipka	62125		m.	2.400	2.880
	PVC spojnica za stub 420-620 5 cm komad	61810		kom.	0.180	0.216
	PVC spojnica za stub 420-620 šipka	62126		m.	2.400	2.880
	PVC spojnica za stub 720 5 cm komad	61803		kom.	0.180	0.216
	PVC spojnica za stub 720 šipka	62111		m.	2.400	2.880
	PVC podmetač za staklo 3-5K 1paket=100kom	61905	1paket=100kom	pak.	3.300	3.960
	PVC podmetač za staklo 4-6K 1paket=100kom	61900	1paket=100kom	pak.	3.300	3.960
	PVC podmetač za staklo 7K 1paket=100kom	61903	1paket=100kom	pak.	3.300	3.960
	PVC Kajle za zastakljivanje stolarije RAVNE 1paket=100kom	61901	1paket=100kom	pak.	2.800	3.360
	PVC Kajle za zastakljivanje stolarije KOSE 1paket=100kom	61902	1paket=100kom	pak.	1.600	1.920
	Dichtung za varenje	61103	Na koturu/m	m.	0.100	0.120

PVC kutija (unutrašnja) 150x195	PVC kutija (unutrašnja) 195x195	PVC kutija (unutrašnja) 230x230				
 <p style="text-align: center;"><b>150x195</b></p> <p>-2 kom Bočni element za PVC kutiju 150 mm -1 kom Gornji element za PVC kutiju 195 mm -1 kom Donji element 162 mm -1 kom Bananica dodatak za spajanje</p>	 <p style="text-align: center;"><b>195x195</b></p> <p>-2 kom Bočni element za PVC kutiju 195 mm -1 kom Gornji element za PVC kutiju 195 mm -1 kom Donji element 162 mm -1 kom Bananica dodatak za spajanje</p>	 <p style="text-align: center;"><b>230x230</b></p> <p>-2 kom Bočni element za PVC kutiju 230 mm -1 kom Gornji element za PVC kutiju 195 mm -1 kom Donji element 162 mm -1 kom Bananica dodatak za spajanje</p>				
PROFILI	NAZIV PROFILA	Šifra Proiz.	BOJA	CENA BEZ PDV-A	CENA SA PDV-OM	
	Bočni element za PVC kutiju Dimenzija: 195 x 150 mm	50094	Bela	1.128	1.353	
	Bočni i gornji element za PVC kutiju Dimenzija: 195 x 195 mm Gonji element za PVC kutiju Dimenzija: 150x195 i 230 x 230 mm	50095	Bela	1.271	1.525	
	Bočni element za PVC kutiju Dimenzija: 230 x 230 mm	50096	Bela	1.743	2.091	
	Donji element za PVC kutije 150x195, 195 x 195 mm i 230 x 230 mm	50093	Bela	1.435	1.722	
	Dodatak zaspajanje PVC kutije - bananica	60051	Bela	0.359	0.431	
	PVC vođica za roletne dupla Dimenzije: 42 x 60 mm	71202	Bela Nesečena	1.394	1.673	
	PVC vođica za roletne i komarnik dupla Dimenzije: 42 x 60 mm	71209	Bela Nesečena	1.525	1.830	
		71225	Laminirana Nesečena	3.829	4.595	
		71228	Antracit Nesečena	3.829	4.595	
	Poklopac za PVC kutiju 195 unutrašnji	30084	kom	0.400	0.480	
	Poklopac za PVC kutiju 195 spoljašnji	30085	kom	0.280	0.336	
	PVC spojnica za spajanje stranica	70848	100 kom	0.020	0.024	
	Izolacija za PVC kutije najmanja obračunska mera 1m'	75007	150x195 - 1m'	1.400	1.680	
		75005	195x195 - 1m'	1.500	1.800	
		75006	230x230 - 1m'	1.850	2.220	

# ROLOPLAST CENOVNIK

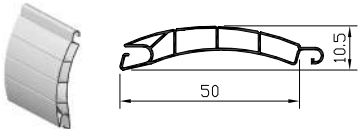
Br. 15

mart 2026

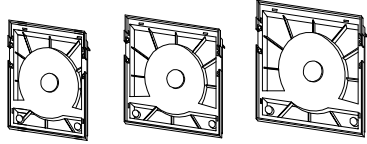
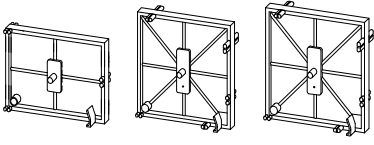



PROFILI	NAZIV PROFILA	Dim.	Jed.	Paket	Korpa Pak/m	Šifra Proiz.	Boja		Cena	
							Nesečena	bez PDV-a	sa PDV-om	
	PVC Letvice za roletne Montira se do širine 1500 mm i max. kvadratura 3.4 m2	50 x 10.5	m2	9.0 m2	28 Pak / 252m2	80306	Bela, Siva	6.355	7.626	
						80307	Drvo	6.355	7.626	
	Spojka za PVC dvokanalnu vođicu 1paket=100kom		pak.	100kom/ pak		61503	Bela	1.400	1.680	
	PVC uvodnik za roletnu za PVC vođicu 42 x 60 100 kom		kom	100 kom		70826	Bela Braon	0.070 0.070	0.084 0.084	
	PVC uvodnik za roletnu i komarnik za PVC vođicu 42 x 60 100 kom		kom	100 kom		70837	Bela Braon	0.070 0.070	0.084 0.084	
	PVC stranica za unutrašnju kutiju bela i braon boja	150x195	kom	70 kom		30066	Bela	1.200	1.440	
		195x195	kom	50 kom		30054	Bela	1.400	1.680	
		230x230	kom	30 kom		30059	Bela	1.700	2.040	
	PVC srednja stranica za unutrašnju kutiju bela boja	150x195	kom	130 kom		30103	Bela	0.700	0.840	
		195x195	kom	100 kom		30058	Bela	0.800	0.960	
		230x230	kom	70 kom		30034	Bela	1.000	1.400	

# ROLOPLAST CENOVNIK

## Delovi za roletne

Br. 16

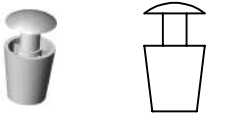
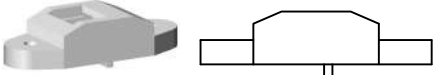
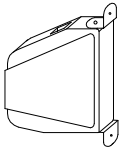
mart 2026

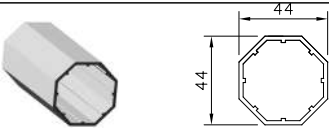
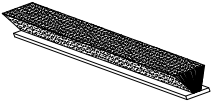
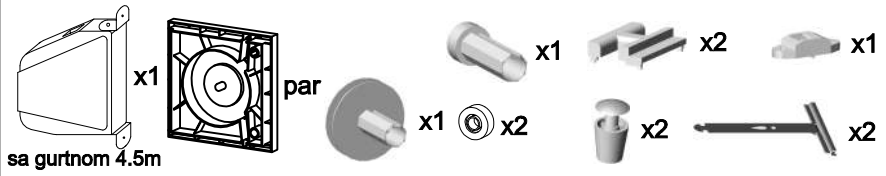
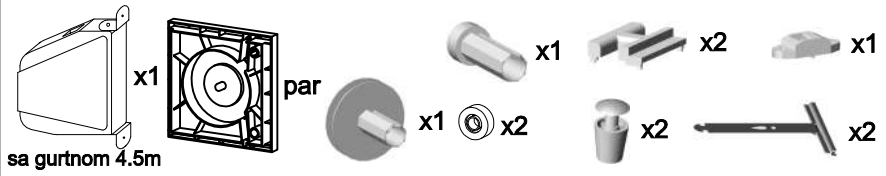
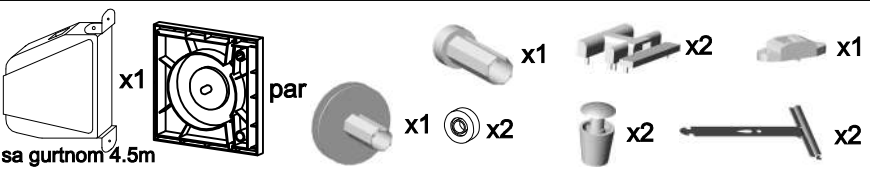
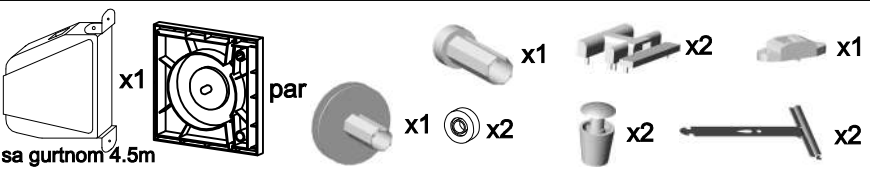
PROFILI	NAZIV PROFILA	Šifra Proiz.	BOJA	Kom	CENA BEZ PDV-A	CENA S PDV-OM
	PVC točak, doboš za namotavanje rolo trake Ø40 100 kom	70031	Crna	kom	0.350	0.420
	PVC završetak na osovina ma Ø40 mm 100 kom	70038	Crna	kom	0.232	0.278
	PVC odbojnik, graničnik za roletnu	70005	Bela Siva Čoko	kom	0.056	0.067
	PVC rolnica sa četkicom za mini rolo traku	70083	Bela	kom	0.167	0.200
	Automat bez gurtne	70025	Bela	kom	1.500	1.800
			Siva	kom	1.708	2.050
			Čoko	kom	1.708	2.050
	Automat sa gurtnom	70026	Bela	kom	1.791	2.150
			Siva	kom	2.000	2.400
			Čoko	kom	2.000	2.400
	Zakacka letvica za osovину za PVC i Al. letvice 39	70701		kom	0.300	0.360
	Zakacka letvica za osovину za PVC i Al. letvice 43	70702		kom	0.300	0.360
	Kuglicni ležaj metalni Ø28	70029		kom	0.150	0.180
	PVC osovine za roletne Ø44 cena bez rabata	71003		m	0.833	1.000
	Četkice 4.8x500	80635		m	0.075	0.090
	Četkice 4.8x700	80637		m	0.083	0.100
<b>PVC SET PAK</b>		300107	150x195 met.ležaj	kom		
		300103	195x195 met.ležaj	kom		
		300105	230x230 met.ležaj	kom		
<b>PVC SET ZA KOMARNIK PAK</b>		300108	150x195 met.ležaj	kom		
		300104	195x195 met.ležaj	kom		
		300106	230x230 met.ležaj	kom		