

# CENOVNIK PROFILA

**roloplast**



**važeći od  
01.03.2023**

## SISTEMSKI METAR

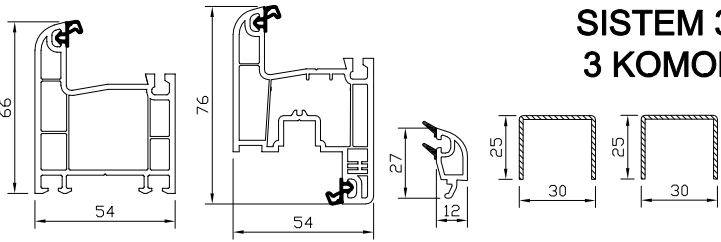
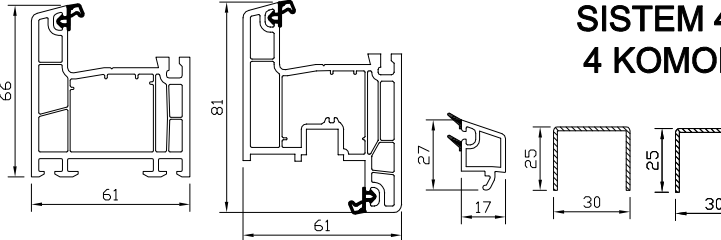
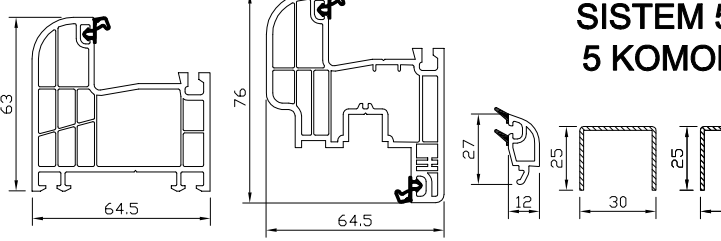
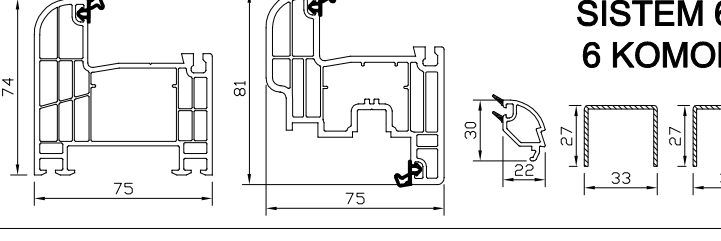
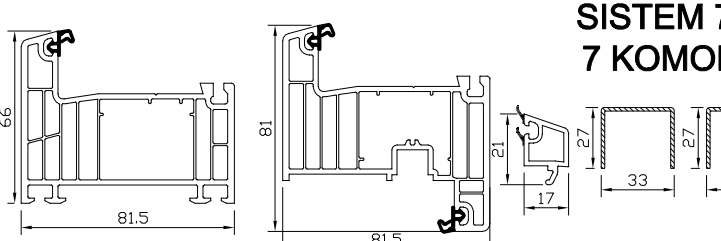
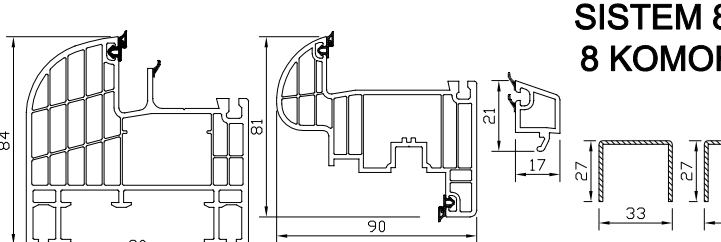
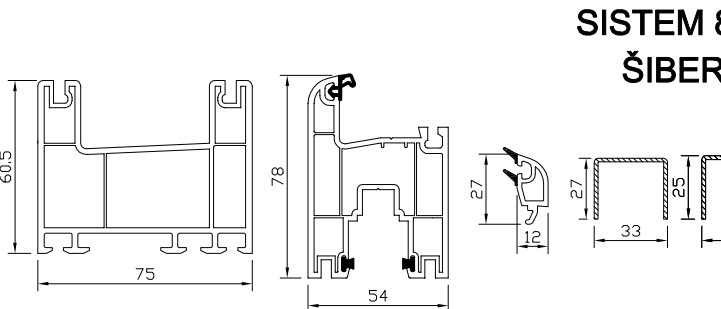
PRIKAZ	BOJA	CENA BEZ PDV-A (EURO/m)	CENA SA PDV-OM (EURO/m)
 <p><b>SISTEM 300 3 KOMORE</b></p>	Bela sa dihtungom	7.0015	8.4018
 <p><b>SISTEM 400 4 KOMORE</b></p>	Bela sa dihtungom	8.1790	9.8148
 <p><b>SISTEM 500 5 KOMORA</b></p>	Bela sa dihtungom	7.684	9.2208
 <p><b>SISTEM 600 6 KOMORA</b></p>	Bela sa dihtungom	8.756	10.5072
	Laminirana sa dihtungom	15.2195	18.2634
	Antracit spolja sa dihtungom	12.1115	14.5338
 <p><b>SISTEM 700 7 KOMORA</b></p>	Bela sa dihtungom	9.3275	11.1930
	Laminirana sa dihtungom	14.5185	17.4222
	Antracit spolja sa dihtungom	11.9675	14.3610
 <p><b>SISTEM 800 8 KOMORA</b></p>	Bela sa dihtungom	10.100	12.1200
 <p><b>SISTEM 800 ŠIBER</b></p>	Bela sa dihtungom i četkicama	7.9570	9.5484

## SISTEM 300 - 3 KOMORA

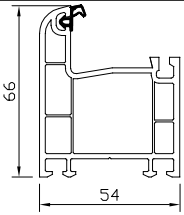
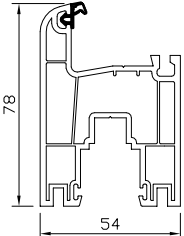
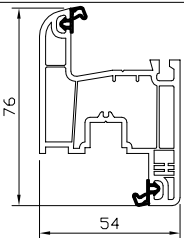
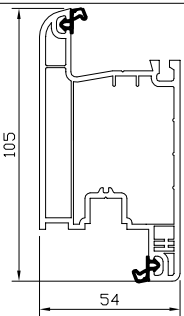
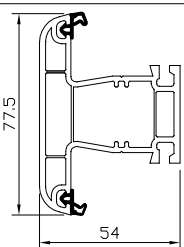
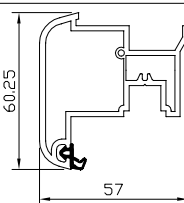
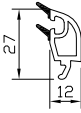
PROFILI	NAZIV PROFILA	Šifra Proiz.	BOJA	Korpa Kom / m	CENA BEZ PDV-A (EURO/m)	CENA SA PDV-OM (EURO/m)
	PVC profil 301 - ram Frame profile (301)	60112	Bela	121 kom / 726m	1.950	2.340
			Bela sa dihtungom	121 kom / 726m	2.050	2.460
	PVC profil 810 - prošireni ram Frame profile (810)	60706	Bela	99 kom / 594m	2.438	2.925
			Bela sa dihtungom	99 kom / 594m	2.538	3.045
	PVC profil 310 - krilo prozora Sash profile (310)	60113	Bela	108 kom / 648m	1.853	2.223
			Bela sa dihtungom	108 kom / 648m	2.053	2.463
	PVC profil 311 - krilo vrata Entrance door sash profile (311)	60114	Bela	77 kom / 462m	2.438	2.925
			Bela sa dihtungom	77 kom / 462m	2.638	3.165
	PVC profil 320 - stub Mullion profile (320)	60115	Bela	121 kom / 726m	1.853	2.223
			Bela sa dihtungom	121 kom / 726m	2.053	2.463
	PVC profil 321 - lažna prečka Sash adapting profile (321)	60116	Bela	154 kom / 924m	1.560	1.872
			Bela sa dihtungom	154 kom / 924m	1.660	1.992
	PVC profil 330 - lajsna za staklo Glassbed profile (330)	60105	Bela sa dihtungom	840 kom / 5040m	0.399	0.479



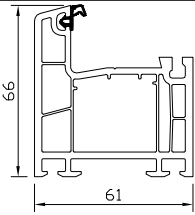
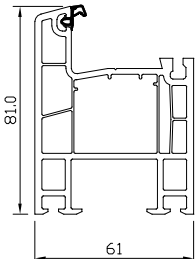
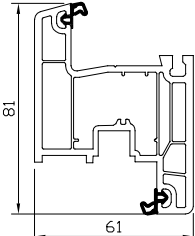
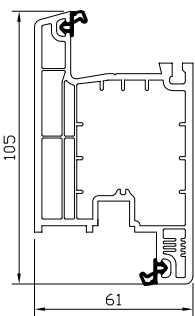
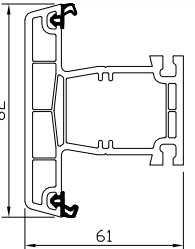
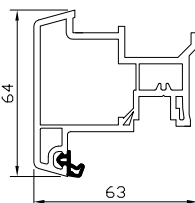
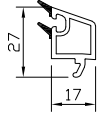

## SISTEM 400 - 4 KOMORA

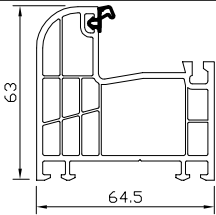
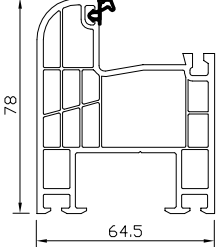
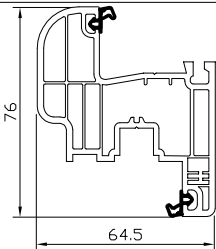
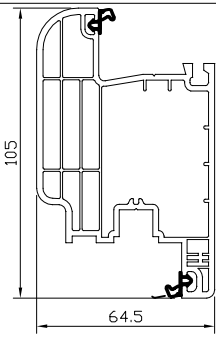
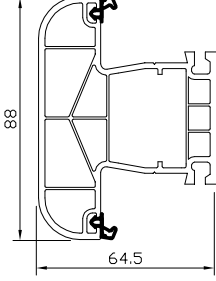
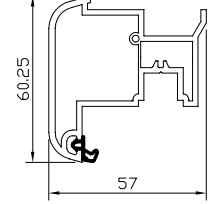
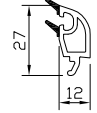
PROFILI	NAZIV PROFILA	Šifra Proiz.	BOJA	Korpa Kom / m	CENA BEZ PDV-A (EURO/m)	CENA SA PDV-OM (EURO/m)
	PVC profil 401 - ram Frame profile (401)		Bela	110 kom / 660m	2.535	3.042
		60212	Bela sa dihtungom	110 kom / 660m	2.635	3.162
	PVC profil 403 - ram Frame profile (403)		Bela	72 kom / 432m	2.633	3.159
		60213	Bela sa dihtungom	72 kom / 432m	2.833	3.399
	PVC profil 410 - krilo prozora Sash profile (410)		Bela	100 kom / 600m	2.633	3.159
		60214	Bela sa dihtungom	100 kom / 600m	2.833	3.399
	PVC profil 411 - krilo vrata Entrance door sash profile (411)		Bela	72 kom / 432m	3.120	3.744
		60215	Bela sa dihtungom	72 kom / 594m	3.320	3.984
	PVC profil 420 - stub Mullion profile (420)		Bela	99 kom / 594m	2.340	2.808
		60216	Bela sa dihtungom	99 kom / 432m	2.540	3.048
	PVC profil 421 - lažna prečka Sash adapting profile (421)		Bela	112 kom / 672m	1.950	2.340
		60217	Bela sa dihtungom	112 kom / 672m	2.050	2.460
	PVC profil 431 - lajsna za staklo Glassbed profile (431)	60206	Bela	640 kom / 3600m	0.504	0.605

## SISTEM 500 - 5 KOMORA

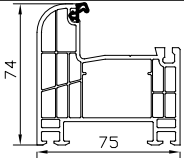
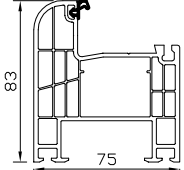
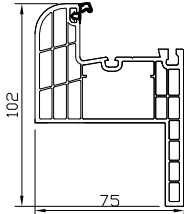
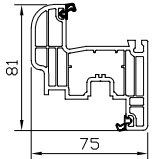
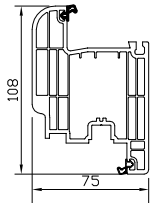
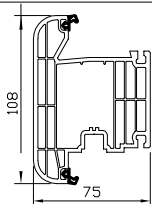
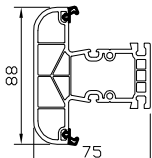
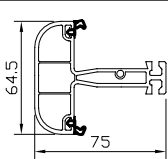
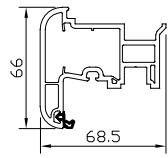
PROFILI	NAZIV PROFILA	Šifra Proiz.	BOJA	Korpa Kom / m	CENA BEZ PDV-A (EURO/m)	CENA SA PDV-OM (EURO/m)
	PVC profil 501 - ram Frame profile (501)	60312	Bela	108 kom / 648m	2.145	2.574
			Bela sa dihtungom	108 kom / 648m	2.245	2.694
	PVC profil 503 - prošireni ram Frame profile (503)	60316	Bela	81 kom / 486m	2.535	3.042
			Bela sa dihtungom	81 kom / 486m	2.635	3.162
	PVC profil 510 - krilo prozora Sash profile (510)	60313	Bela	99 kom / 594m	2.340	2.808
			Bela sa dihtungom	99 kom / 594m	2.540	3.048
	PVC profil 511 - krilo vrata Entrance door sash profile (511)	60319	Bela	63 kom / 376m	2.730	3.276
			Bela sa dihtungom	63 kom / 376m	2.930	3.516
	PVC profil 520 - stub Mullion profile (520)	60318	Bela	81 kom / 486m	2.535	3.042
			Bela sa dihtungom	81 kom / 486m	2.735	3.282
	PVC profil 321 - lažna prečka Sash adapting profile 321	60116	Bela	160 kom / 960m	1.560	1.872
			Bela sa dihtungom	160 kom / 960m	1.660	1.992
	PVC profil 330 -lajsna za staklo Glassbed profile 330	60105	Bela sa dihtungom	840 kom / 4200m	0.399	0.479

## SISTEM 600 - 6 KOMORA

PROFILI	NAZIV PROFILA	Šifra Proiz.	BOJA	Korpa Kom / m	CENA BEZ PDV-A (EURO/m)	CENA SA PDV-OM (EURO/m)
	PVC profil 601 - ram Frame profile (601)		Bela	80 kom / 480m	2.633	3.159
		60412	Bela sa dihtungom	80 kom / 480m	2.733	3.279
	PVC profil 603 - prošireni ram Frame profile (603)		Bela	72 kom / 432m	2.964	3.557
		60418	Bela sa dihtungom	72 kom / 432m	3.064	3.677
		60626	Laminirana sa dihtungom	72 kom / 432m	5.848	7.018
		60635	Antracit spolja sa dihtungom	72 kom / 432m	4.760	5.712
	PVC profil 605 - ram sa pervajzom Frame profile (605)		Bela	64 kom / 384m	2.535	3.042
		60424	Bela sa dihtungom	64 kom / 384m	2.635	3.162
		60634	Laminirana sa dihtungom	64 kom / 384m	5.499	6.599
	PVC profil 610 - krilo prozora Sash profile (610)		Bela	80 kom / 480m	2.633	3.159
		60413	Bela sa dihtungom	80 kom / 480m	2.833	3.399
		60620	Laminirana sa dihtungom	80 kom / 480m	5.409	6.490
	PVC profil 611 - krilo vrata Entrance door - sash profile (611)		Bela	56 kom / 336m	3.705	4.446
		60414	Bela sa dihtungom	56 kom / 336m	3.905	4.686
		60621	Laminirana sa dihtungom	56 kom / 336m	7.345	8.814
	PVC profil 612 - krilo vrata za spoljašnje otvaranje Entrance door sash profile for external opening (612)		Bela	56 kom / 336m	3.803	4.563
		60415	Bela sa dihtungom	56 kom / 336m	4.003	4.803
		60630	Laminirana sa dihtungom	56 kom / 336m	7.443	8.931
	PVC profil 620 - stub Mullion profile (620)		Bela	72 kom / 432m	3.218	3.861
		60416	Bela sa dihtungom	72 kom / 432m	3.418	4.101
		60622	Laminirana sa dihtungom	72 kom / 432m	6.266	7.519
	PVC profil 622 - stub Mullion profile (622)		Bela	112 kom / 672m	1.853	2.223
		60419	Bela sa dihtungom	112 kom / 672m	2.053	2.463
		60633	Laminirana sa dihtungom	112 kom / 672m	4.149	4.978
	PVC profil 621 - lažna prečka Sash adapting profile (621)		Bela	117 kom / 702m	2.145	2.574
		60417	Bela sa dihtungom	117 kom / 702m	2.245	2.694
		60623	Laminirana sa dihtungom	117 kom / 702m	4.325	5.190
	PVC profil 630 - lajsna za staklo Glassbed profile (630)	60406	Bela sa dihtungom	500 kom / 3000m	0.609	0.731
		60606	Laminirana sa dihtungom		1.297	1.556
	PVC profil 631 - lajsna za staklo Glassbed profile (631)	60420	Bela sa dihtungom	500 kom / 3000m	0.525	0.630
	PVC profil 330 - lajsna za troslojno staklo Glassbed profile (330)	60105	Bela sa dihtungom	840 kom / 5040m	0.399	0.479
		60118	Laminirana sa dihtungom		1.119	1.343

## SISTEM 700 - 7 KOMORA

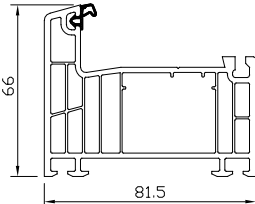
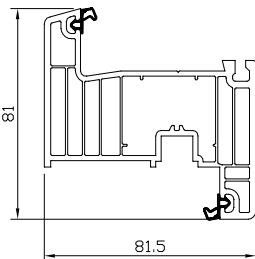
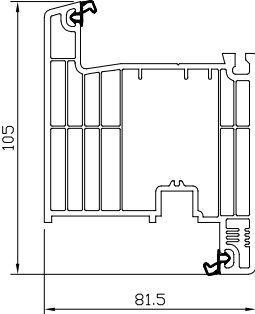
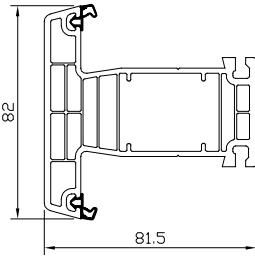
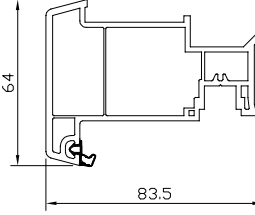
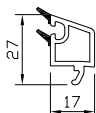
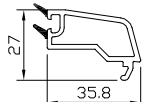



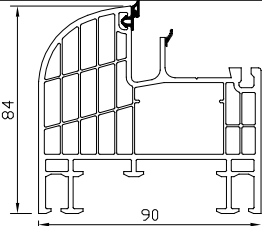
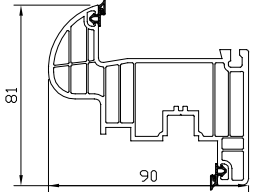
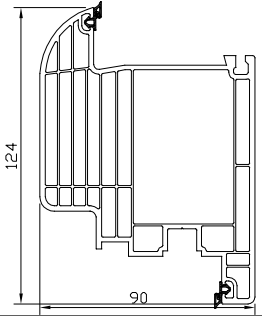
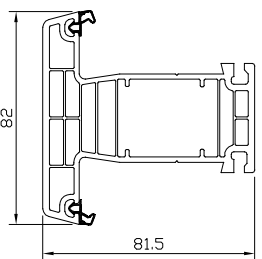
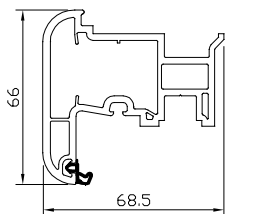
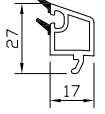
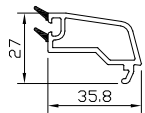

PROFILI	NAZIV PROFILA	Šifra Proiz.	BOJA	Korpa Kom / m	CENA BEZ PDV-A (EURO/m)	CENA SA PDV-OM (EURO/m)
	PVC profil 701 - ram Frame profile (701)		Bela	77 kom / 462m	2.730	3.276
		60801	Bela sa dihtungom	77 kom / 462m	2.830	3.396
		62500	Laminirana sa dihtungom	77 kom / 462m	5.038	6.046
		62506	Antracit spolja sa dihtungom	77 kom / 462m	4.174	5.009
	PVC profil 710 - krilo prozor Sash profile (710)		Bela	70 kom / 420 m	3.023	3.627
		60802	Bela sa dihtungom	70 kom / 420 m	3.223	3.867
		62501	Laminirana sa dihtungom	70 kom / 420 m	5.735	6.881
		62507	Antracit spolja sa dihtungom	70 kom / 420 m	4.519	5.422
	PVC profil 711 - krilo vrata Entrance door - sash profile (711)		Bela	49 kom / 294 m	3.705	4.446
		60803	Bela sa dihtungom	49 kom / 294m	3.905	4.686
		62502	Laminirana sa dihtungom	49 kom / 294 m	7.185	8.622
		62508	Antracit spolja sa dihtungom	49 kom / 294 m	5.585	6.702
	PVC profil 720 - stub Mullion profile (720)		Bela	70 kom / 420 m	2.828	3.393
		60804	Bela sa dihtungom	70 kom / 420 m	3.028	3.633
		62503	Laminirana sa dihtungom	70 kom / 420 m	5.572	6.686
		62509	Antracit spolja sa dihtungom	70 kom / 420 m	4.772	5.726
	PVC profil 721 - lažna prečka Sash adapting profile (721)		Bela	91 kom / 546 m	2.048	2.457
		60805	Bela sa dihtungom	91 kom / 546 m	2.148	2.577
		62504	Laminirana sa dihtungom	91 kom / 546 m	4.244	5.092
		62510	Antracit spolja sa dihtungom	91 kom / 546 m	3.572	4.286
	PVC profil 431 - lajsna za staklo Glassbed profile(431)	60206	Bela sa dihtungom	600 kom / 3600m	0.504	0.605
		62505	Laminirana sa dihtungom	600 kom / 3600m	1.080	1.296
	PVC profil 730 - lajsna za staklo Glassbed profile(730)	60812	Bela sa dihtungom	kom / 00m	0.609	0.731
		62511	Laminirana sa dihtungom	kom / 00m	1.409	1.691

## SISTEM 800 - 8 KOMORA

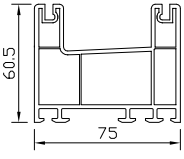
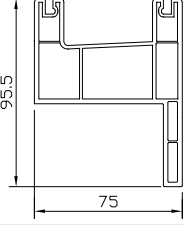
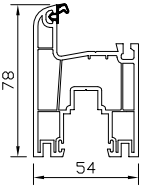
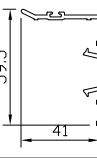
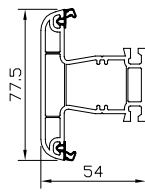
PROFILI	NAZIV PROFILA	Šifra Proiz.	BOJA	Korpa Kom / m	CENA BEZ PDV-A (EURO/m)	CENA SA PDV-OM (EURO/m)
	PVC profil 802 - ram Frame profile(802)		Bela	72 kom / 432m	3.705	4.446
		62400	Bela sa dihtungom	72 kom / 432m	3.805	4.566
	PVC profil 811 - krilo prozora Sash profile (811)		Bela	72 kom / 432m	2.925	3.510
		60707	Bela sa dihtungom	72 kom / 432m	3.125	3.750
	PVC profil 812 - krilo vrata Entrance door sash profile (812)		Bela	36 kom / 216m	4.290	5.148
		60709	Bela sa dihtungom	36 kom / 216m	4.490	5.388
	PVC profil 720 - stub Mullion profile (720)		Bela	36 kom / 216m	2.828	3.393
		60804	Bela sa dihtungom	36 kom / 216m	3.028	3.633
	PVC profil 621 - lažna prečka Sash adapting profile (621)		Bela	117 kom / 702m	2.145	2.574
		60417	Bela sa dihtungom	117 kom / 702m	2.245	2.694
	PVC profil 431 - lajsna za staklo Glassbed profile (431)	60206	Bela sa dihtungom	500 kom / 3000m	0.504	0.605
	PVC profil 730 - lajsna za staklo Glassbed profile (730)	60812	Bela sa dihtungom		0.609	0.731



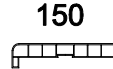
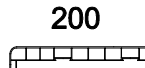
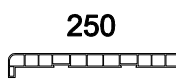
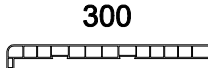
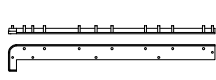

## SISTEM 800 - ŠIBER

PROFILI	NAZIV PROFILA	Šifra Proiz.	BOJA	Korpa Kom / m	CENA BEZ PDV-A (EURO/m)	CENA SA PDV-OM (EURO/m)
	Profil rama (801)	60700	Bela	77 kom / 462m	2.438	2.925
	Profil rama (801) sa pervajzom	60714	Bela	73 kom / 438m	2.340	2.808
	PVC profil 810 - prošireni ram Frame profile (810)	60706	Bela	90 kom / 540m	2.438	2.925
			Bela sa dihtungom	90 kom / 540m	2.538	3.045
	Profil "L" klizni (820)	60702	Bela	kom / m	0.731	0.878
	PVC profil 320 - stub Mullion profile (320)	60115	Bela	120 kom / 720m	1.853	2.223
			Bela sa dihtungom	120 kom / 720m	2.053	2.463
	PVC profil 330 - lajsna za staklo Glassbed profile (330)	60105	Bela sa dihtungom	840 kom / 4200m	0.399	0.479
	Donja šina za klizni sistem	60713		kom / m	1.250	1.500
	Ukrasna lajsna za opšivanje 23x23mm	62118	Bela	kom / m	0.366	0.439
		62119	Laminirana	kom / m	1.118	1.341
	Podprozorska daska 150	62014	Bela	120 kom / 720m	1.663	1.995
	Podprozorska daska 200	62016	Bela	90 kom / 540m	1.971	2.365
	Podprozorska daska 250	62000	Bela	72 kom / 432m	2.713	3.255
		62002	Laminirana		7.241	8.689
	Podprozorska daska 300	62005	Bela	60 kom / 360m	3.500	4.200
	PVC čep za podprozorsku dasku (300)	61201	Bela	200 par /velika kut.	0.280 par	0.336 par
		61301	Siva		0.280 par	0.336 par
		61401	Braon	50 par /mala kut.	0.280 par	0.336 par
	PVC profil ispune	62100	Bela	150 kom / 900m	1.365	1.638
		62102	Laminirana		4.853	5.824

# ROLOPLAST CENOVNIK

Br. 9

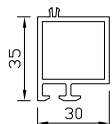
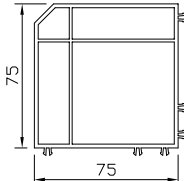
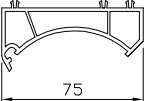
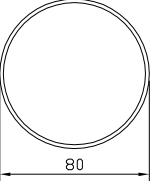
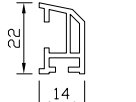
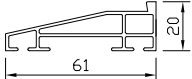
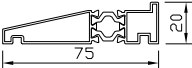
mart 2023

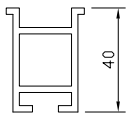
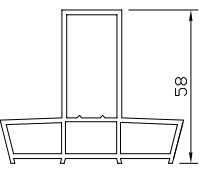
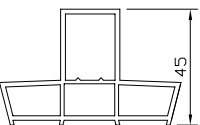
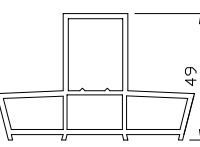
PROFILI	NAZIV PROFILA	Šifra Proiz.	BOJA	Korpa Kom / m	CENA BEZ PDV-A (EURO/m) PRICE (EURO/m)	CENA SA PDV-OM (EURO/m) PRICE (EURO/m)
	<b>PVC profil 402</b> <b>Proširenje štoka</b> <b>Frame elevation profile (402)</b>	60207	Bela	323 kom / 1938m	0.878	1.053
		60627	Laminirana	323 kom / 1938m	2.302	2.762
	<b>PVC profil 440 ugao 90°</b> <b>90° Angled box profile (440)</b>	60208	Bela	64 kom / 384m	3.047	3.656
	<b>PVC profil 450 ugao štelujući</b> <b>Angled turning adapter profile (450)</b>	60209	Bela	kom / m	1.828	2.194
		60628	Laminirana	kom / m	4.000	4.800
	<b>PVC profil 460 Ø80</b> <b>Angled post pipe profile (460)</b>	60210	Bela	kom / m	1.950	2.340
		60629	Laminirana	kom / m	5.694	6.833
	<b>PVC profil 470</b> <b>okapnica za krilo</b>	60211	Bela	kom / m	0.500	0.600
	<b>Aluminijumski prag</b> <b>Aluminium sill profile</b>	62104	Nefarbano	kom / m	6.000	7.200
		62105	P L F C	kom / m	7.000	8.400
	<b>Aluminijumski prag sa termoprekidom</b> <b>Aluminium sill profile</b>	62124	P L F C	kom / m	8.500	10.200
	<b>PVC profil 100 spojka za štok</b> <b>Coupling profile (100)</b>	62110	Bela, Braon Lešnik, Siva	kom / m	0.300	0.360
	<b>PVC profil 101 adaptera za podprozorsku dasku</b> <b>Wall connection profile (101)</b>	62103	Bela	kom / m	0.788	0.945
	<b>PVC profil 102 "T" adaptera za podprozorsku dasku</b> <b>Wall connection profile "T" (102)</b>	62106	Bela	kom / m	1.365	1.638
	<b>PVC profil 103 "T" adaptera za podproz. dasku, kraći</b> <b>Wall connection profile "T" shorter (103)</b>	62108	Bela	kom / m	1.138	1.365
	<b>PVC profil 104 "T" adaptera za podproz. dasku, kraći za profil 601</b> <b>Wall connection profile "T" shorter (104)</b>	62101	Bela	kom / m	0.963	1.155

# ROLOPLAST CENOVNIK

Br. 10

avgust

2023

## PROFILI

## OJAČANJA

## OPIS

CENA BEZ  
PDV-a  
(EURO/m)

CENA SA  
PDV-om  
(EURO/m)

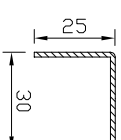
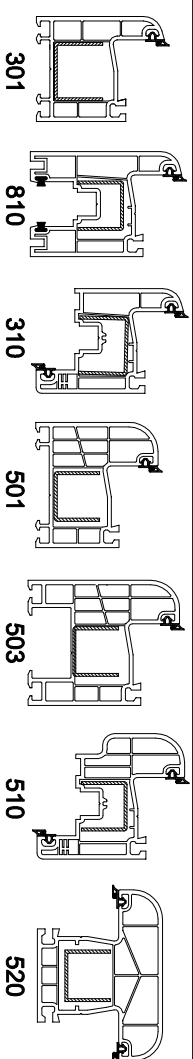

Čelik za štok, krilo, i lažnu prečku  
3k, 5k i 4k i stub 5k  
(253025)  
Reinforcement profile (253025)

1.166

1.400

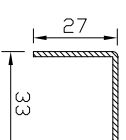
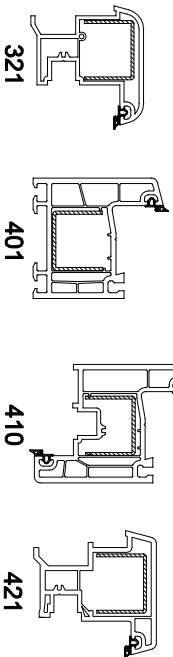

Čelik za štok i krilo 6k (273327)  
Reinforcement profile (273327)

1.250

1.500

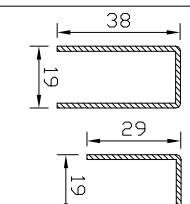
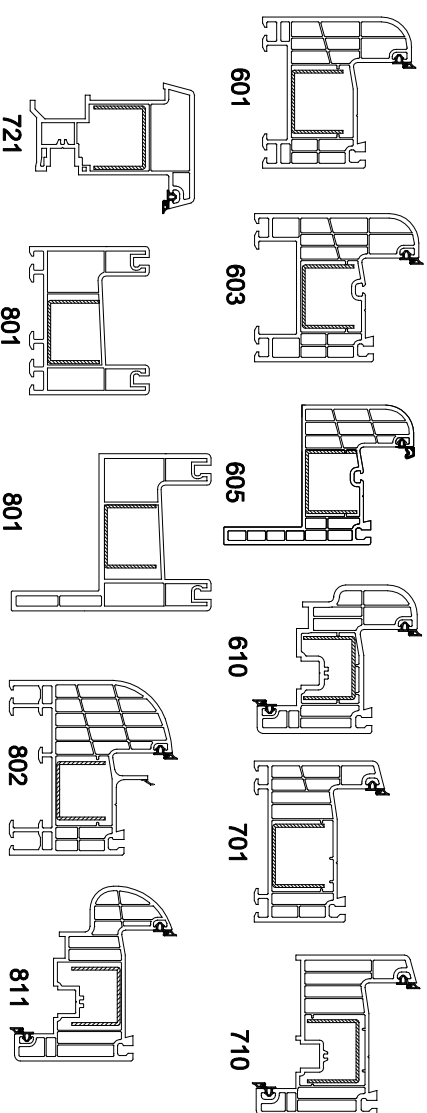

Čelik za stub 4k, 6k i lažnu prečku (381938)  
Reinforcement profile (381938)  
Čelik za stub 3k (291929)  
Reinforcement profile (291929)

1.666

2.000

1.542

1.850

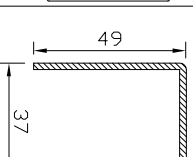
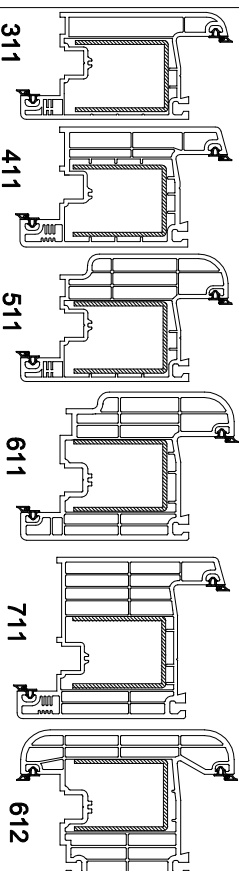
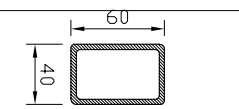
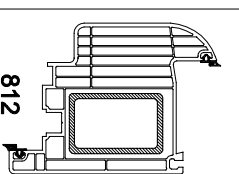
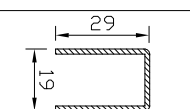
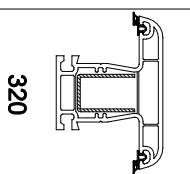

Čelik za krilo vrata 3k, 4k, 5k i 6k (493749)  
Reinforcement profile (493749)

2.833

3.400

PROFILI	NAZIV PROFILA	Šifra Proiz.	BOJA	Jed.	CENA BEZ PDV-A	CENA SA PDV-OM
	Čep za lažnu prečku (321 i 521) 100 par.	61202	Bela	par.	0.250par	0.300par
	Čep za lažnu prečku (421) 100 par.	61203	Bela	par.	0.250par	0.300par
	Čep za lažnu prečku (621) 100 par.	61204	Bela	par.	0.250par	0.300par
		61304	Siva	par.	0.250par	0.300par
		61404	Braon	par.	0.250par	0.300par
		61219	Antracit	par.	0.250par	0.300par
	Čep za lažnu prečku (721) 50 par.	61214	Bela	par.	0.250par	0.300par
		61216	Siva	par.	0.250par	0.300par
		61215	Braon	par.	0.250par	0.300par
	PVC Spojka Štok (301)-Prag 3k 50 par.	61500	Bela	par.	0.400par	0.480par
	PVC Spojka Štok (401)-Prag 4k 50 par.	61501	Bela	par.	0.400par	0.480par
	PVC Spojka Štok (501)-Prag 5k 50 par.	61505	Bela	par.	0.400par	0.480par
	PVC Spojka Štok (501)-Termo Prag 5k 50 par.	61510	Bela	par.	0.400par	0.480par
	PVC Spojka Štok (601)-Prag 6k 50 par.	61602	Siva	par.	0.400par	0.480par
		61502	Bela	par.	0.400par	0.480par
		61702	Braon	par.	0.400par	0.480par
	PVC Spojka Štok (601)-Termo Prag 6k 50 par.	61511	Bela	par.	0.400par	0.480par
	PVC Spojka Štok (603)-Termo Prag 6k 50 par.	61512	Bela	par.	0.400par	0.480par
	PVC Spojka Štok (603)-Termo Prag 6k 50 par.	61513	Braon	par.	0.400par	0.480par
	PVC Spojka Štok (603)-Termo Prag 6k 50 par.	61514	Siva	par.	0.400par	0.480par
	PVC Spojka Štok (701)-Prag 7k 50 par.	61509	Bela	par.	0.400par	0.480par
	PVC Spojka Štok (701)-Termo Prag 7k 50 par.	61515	Bela	par.	0.400par	0.480par
	PVC Spojka Štok (701)-Termo Prag 7k 50 par.	61516	Braon	par.	0.400par	0.480par
	PVC Spojka Štok (701)-Termo Prag 7k 50 par.	61517	Siva	par.	0.400par	0.480par
	PVC Spojka Štok (801)-Prag 8k 50 par.	61506	Bela	par.	0.400par	0.480par
		61604	Siva	par.	0.400par	0.480par
		61704	Braon	par.	0.400par	0.480par
	Čep za vodu (kondenz otvore) 1paket=100kom 1kutija=2000kom	61205	Bela	pak.	1.400 pak.	1.680 pak.
		61305	Siva	pak.	1.400 pak.	1.680 pak.
		61405	Braon	pak.	1.400 pak.	1.680 pak.
		61218	Antracit	pak.	1.400 pak.	1.680 pak.
	Čep za okpanicu 1paket=100kom	61206	Bela	pak.	1.400 pak.	1.680 pak.
	PVC Čep za rupu Ø13 1paket=100kom 1kutija=1000kom	61207	Bela	pak.	1.400 pak.	1.680 pak.
		61307	Siva	pak.	1.400 pak.	1.680 pak.
		61407	Braon	pak.	1.400 pak.	1.680 pak.
		61408	Antracit	pak.	1.400 pak.	1.680 pak.
	Podloška za šiber 250 kom	61807		kom	0.280	0.336

**ROLOPLAST CENOVNIK**







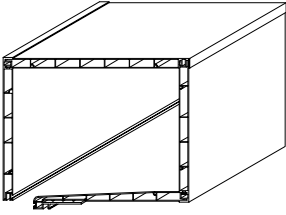
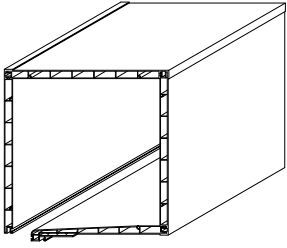
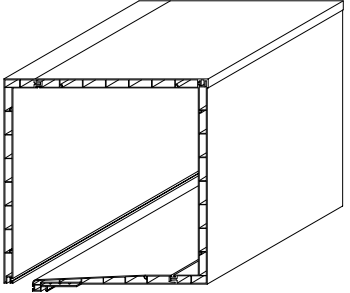

61816

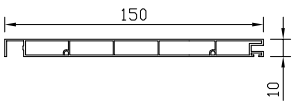
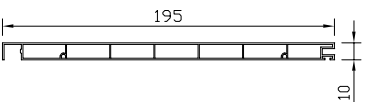
Br. 12

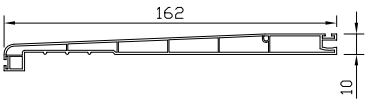
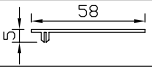
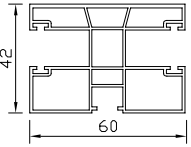
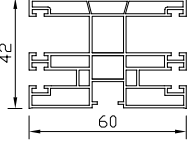
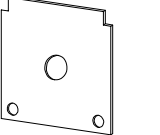
mart 2023

PROFILI	NAZIV PROFILA	Šifra Proiz.	Pakovanje	Jed.	CENA BEZ PDV-A	CENA SA PDV-OM
	Aluminijumska spojnica za stub (320 i 520)	61801		par.	0.600 par	0.720 par
	Aluminijumska spojnica nova za stub (420)	61815		par.	0.600 par	0.720 par
	Aluminijumska spojnica nova za stub (720) i (620)	61816		par.	0.600 par	0.720 par
	PVC spojnica za stub 320 -520 5 cm komad	61809		kom.	0.180	0.216
	PVC spojnica za stub 320-520 šipka	62125		m.	2.400	2.880
	PVC spojnica za stub 420-620 5 cm komad	61810		kom.	0.180	0.216
	PVC spojnica za stub 420-620 šipka	62126		m.	2.400	2.880
	PVC spojnica za stub 720 5 cm komad	61803		kom.	0.180	0.216
	PVC spojnica za stub 720 šipka	62111		m.	2.400	2.880
	PVC podmetač za staklo 3-5K 1paket=100kom	61905	1paket=100kom	pak.	3.300	3.960
	PVC podmetač za staklo 4-6K 1paket=100kom	61900	1paket=100kom	pak.	3.300	3.960
	PVC podmetač za staklo 7K 1paket=100kom	61903	1paket=100kom	pak.	3.300	3.960
	PVC Kajle za zastakljivanje stolarije RAVNE 1paket=100kom	61901	1paket=100kom	pak.	2.800	3.360
	PVC Kajle za zastakljivanje stolarije KOSE 1paket=100kom	61902	1paket=100kom	pak.	1.600	1.920
	Dichtung za varenje	61103	Na koturu/m	m.	0.100	0.120

PVC kutija (unutrašnja) 150x195	PVC kutija (unutrašnja) 195x195	PVC kutija (unutrašnja) 230x230
		
<b>150x195</b>	<b>195x195</b>	<b>230x230</b>
-2 kom Bočni element za PVC kutiju 150 mm -1 kom Gornji element za PVC kutiju 195 mm -1 kom Donji element 162 mm -1 kom Bananica dodatak za spajanje	-2 kom Bočni element za PVC kutiju 195 mm -1 kom Gornji element za PVC kutiju 195 mm -1 kom Donji element 162 mm -1 kom Bananica dodatak za spajanje	-2 kom Bočni element za PVC kutiju 230 mm -1 kom Gornji element za PVC kutiju 195 mm -1 kom Donji element 162 mm -1 kom Bananica dodatak za spajanje

PROFILI	NAZIV PROFILA	Šifra Proiz.	BOJA	CENA BEZ PDV-A	CENA SA PDV-OM
	Bočni element za PVC kutiju Dimenzija: 195 x 150 mm	50094	Bela	1.018	1.221
	Bočni i gornji element za PVC kutiju Dimenzija: 195 x 195 mm	50095	Bela	1.147	1.376
	Gonji element za PVC kutiju Dimenzija: 150x195 i 230 x 230 mm	50055	Laminirana	4.587	5.504
	Bočni element za PVC kutiju Dimenzija: 230 x 230 mm	50096	Bela	1.573	1.887
	Donji element za PVC kutije 150x195, 195 x 195 mm i 230 x 230 mm	50093	Bela	1.203	1.443
		50099	Laminirana	2.563	3.075
	Dodatak zaspajanje PVC kutije - bananica	60051	Bela	0.300	0.360
	PVC vođica za roletne dupla Dimenzije: 42 x 60 mm	71202	Bela Nesečena	1.258	1.510
	PVC vođica za roletne i komarnik dupla Dimenzije: 42 x 60 mm	71209	Bela Nesečena	1.376	1.652
		71225	Laminirana Nesečena	3.680	4.416
		71228	Antracit Nesečena	3.680	4.416
	Poklopac za PVC kutiju 195 unutrašnji	30084	kom	0.400	0.480
	Poklopac za PVC kutiju 195 spoljašnji	30085	kom	0.280	0.336
	PVC spojnica za spajanje stranica	70848	100 kom	0.020	0.024
	Izolacija za PVC kutije najmanja obračunska mera 1m'	75007	150x195 - 1m'	1.400	1.680
		75005	195x195 - 1m'	1.500	1.800
		75006	230x230 - 1m'	1.850	2.220

# ROLOPLAST CENOVNIK

Br. 14

mart 2023







PROFILI	NAZIV PROFILA	Dim.	Jed.	Paket	Korpa Pak/m	Šifra Proiz.	Boja		Cena	
							Nesečena	bez PDV-a	sa PDV-om	
	PVC Letvice za roletne Montira se do širine 1500 mm i max. kvadratura 3.4 m <sup>2</sup>	50 x 10.5	m <sup>2</sup>	9.0 m <sup>2</sup>	28 Pak / 252m <sup>2</sup>	80306	Bela, Siva	5.735	6.882	
						80307	Drvo	5.735	6.882	
	Al. letvica za roletne Montira se do širine 2000 mm i max. kvadrature 4.5 m <sup>2</sup>	39 x 8	m <sup>2</sup>	14.04 m <sup>2</sup>	21 Pak / 294.84 m <sup>2</sup>	75102	Bela	12.300	14.760	
						75111	Braon	13.400	16.080	
						75112	Siva	13.400	16.080	
						75107	Orah, Zlatni hrast	15.600	18.720	
						75105	Drvo, Mahagoni	15.600	18.720	
						75120	Antracit	14.500	17.400	
	Al. letvice za roletne Montira se do širine 2500 mm i max. kvadrature 5.5 m <sup>2</sup>	43 x 10	m <sup>2</sup>	7.74 m <sup>2</sup>	32 Pak / 247.68 m <sup>2</sup>	80902	Bela	12.300	14.760	
						80903	Braon	13.400	16.080	
						80904	Siva	13.400	16.080	
						80905	Drvo	15.600	18.720	
	Al. letvice za roletne Montira se do širine 3000 mm i max. kvadrature 7.0 m <sup>2</sup>	55 x 14	m <sup>2</sup>	9.9 m <sup>2</sup>	15 Pak / 148.5 m <sup>2</sup>	81003	Bela	18.000	21.600	
						81004	Braon	19.000	22.800	
						81004	Siva	17.000	20.400	
						81006	Drvo	17.000	20.400	
	Al. letvica za garažna vrata punjena poliuretanskom penom. Montira se do širine 5000 mm, i max. do 15 m <sup>2</sup>	77 x 18	m <sup>2</sup>	4.62 m <sup>2</sup>		97202	Belo sečeno na meru	29.000	34.800	
						97203	Braon sečeno na meru	30.000	36.000	
						97204	Siva sečeno na meru	30.000	36.000	
	PVC čepovi za Al. letvice	za 39	kom	1000 kom/ pak		70800	Nefarbano	0.007	0.008	
		za 43	kom	500 kom/ pak		70801	Nefarbano	0.008	0.010	
		za 55	kom	500 kom/ pak		70802	Nefarbano	0.014	0.017	
		za 77	kom	100 kom/ pak		70803	Nefarbano	0.028	0.034	
	Spojka za PVC dvokanalnu vođicu 1paket=100kom			pak.	100kom/ pak	61503	Bela	1.400	1.680	
	PVC uvodnik za roletnu za PVC vođicu 42 x 60 100 kom			kom	100 kom		Bela	0.070	0.084	
						70826	Braon	0.070	0.084	
	PVC uvodnik za roletnu i komarnik za PVC vođicu 42 x 60 100 kom			kom	100 kom		Bela	0.070	0.084	
						70837	Braon	0.070	0.084	
	PVC stranica za unutrašnju kutiju bela i braon boja	150x195	kom	70 kom		30066	Bela	1.200	1.440	
		195x195	kom	50 kom		30054	Bela	1.400	1.680	
		230x230	kom	30 kom		30059	Bela	1.700	2.040	
	PVC srednja stranica za unutrašnju kutiju bela boja	150x195	kom	130 kom		30103	Bela	0.700	0.840	
		195x195	kom	100 kom		30058	Bela	0.800	0.960	
		230x230	kom	70 kom		30034	Bela	1.000	1.400	

# ROLOPLAST CENOVNIK

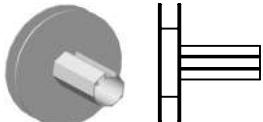
## Delovi za roletne

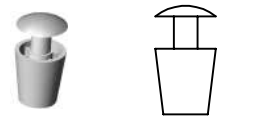
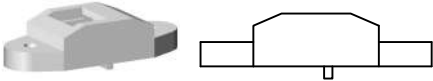
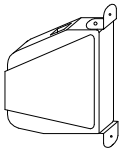
Br. 15

mart 2023

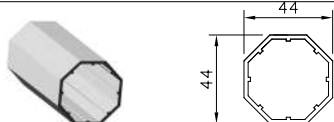
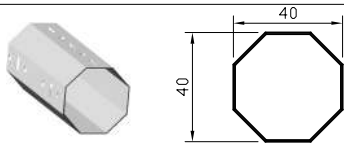
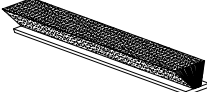
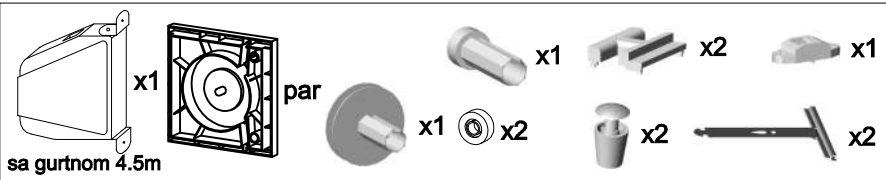
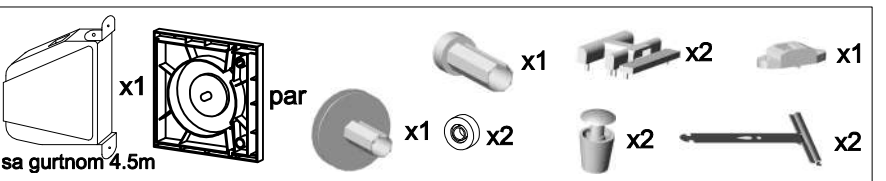
PROFILI	NAZIV PROFILA	Šifra Proiz.	BOJA	Kom	CENA BEZ PDV-A	CENA S PDV-OM	
	PVC točak, doboš za namotavanje rolo trake Ø40 100 kom	70031	Crna	kom	0.350	0.420	
	PVC završetak na osovinama Ø40 mm 100 kom	70038	Crna	kom	0.232	0.278	
	PVC odbojnik, graničnik za roletnu	70005	Bela Siva Čoko	kom	0.056	0.067	
	PVC rolnica sa četkicom za mini rolo traku	70083	Bela	kom	0.208	0.250	
	Automat bez gurtne	70025	Bela	kom	1.667	2.000	
			Siva	kom	1.667	2.000	
			Čoko	kom	1.667	2.000	
	Automat sa gurtnom	70026	Bela	kom	1.958	2.350	
			Siva	kom	1.958	2.350	
			Čoko	kom	1.958	2.350	
	Zakacka letvica za osovinu za PVC i Al. letvice 39	70701		kom	0.300	0.360	
	Zakacka letvica za osovinu za PVC i Al. letvice 43	70702		kom	0.300	0.360	
	Kuglicni ležaj metalni Ø28	70029		kom	0.150	0.180	
	PVC osovine za roletne Ø36	71000		m	0.833	1.000	
	PVC osovine za roletne Ø44	71003		m	0.833	1.000	
	Metalna oklagija Ø40	71006		m	1.500	1.800	
	Četkice 4.8x500	80635		m	0.075	0.090	
	Četkice 4.8x700	80637		m	0.083	0.100	
<b>PVC SET PAK</b>		300107	150x195 met.ležaj	kom	6.300	7.561	
	sa gurtnom 4.5m		300103	195x195 met.ležaj	kom	6.701	8.041
			300105	230x230 met.ležaj	kom	7.301	8.761
	<b>PVC SET ZA KOMARNIK PAK</b>		300108	150x195 met.ležaj	kom	6.300	7.561
	sa gurtnom 4.5m		300104	195x195 met.ležaj	kom	6.701	8.041
			300106	230x230 met.ležaj	kom	7.301	8.761